

***TAMA300:  
current status  
and***

***the joint observation with LIGO***

***National Astronomical Observatory of Japan***

***Koji Arai (TAMA project)***

# **Overview of this talk**

- **Introduction of TAMA300**

- a 300-m Fabry-Perot Michelson interferometer*
  - 8 observations in past*

- **The 6th observation: Data Taking 6**

- The observation for 50 days in the summer of 2001*
  - Analyses of the 1038-hours data*

- **The 8th observation: Data Taking 8  
(= LIGO S2)**

- LIGO-TAMA joint observation for 2 months*
  - Detector development for DT8*
  - Operational status*

# Overview of this talk

- **Introduction of TAMA300**  
*a 300-m Fabry-Perot Michelson interferometer*  
*8 observations in past*
- **The 6th observation: Data Taking 6**  
*The observation for 50 days in the summer of 2001*  
*Analyses of the 1038-hours data*
- **The 8th observation: Data Taking 8**  
**(= LIGO S2)**  
*LIGO-TAMA joint observation for 2 months*  
*Detector development for DT8*  
*Operational status*

# TAMA300

- **Laser interferometric GW detector**

□ □ □ □ □ □ □ □ □ □ □ **with arm length of 300m**

Site: National Astronomical Observatory of Japan,  
□ □ (Mitaka, Tokyo)

- **Object of the project**

To develop a detector capable to detect GW events

□ □ □ □ □ □ □ □ □ □ □ □ □ in nearby galaxies.

To establish techniques for a future km-class interferometer

Designed sensitivity  $\sim h_{\text{RMS}} = 3 \times 10^{-21}$  @300Hz (BW300Hz)

# ***Bird's view of the TAMA site***

## **● *National Astronomical Observatory of Japan***

***Tokyo, Mitaka Campus (E139.32.21 N35.40.25)***

***West  
End  
Room***

***Center  
Room***

***South  
End  
Room***

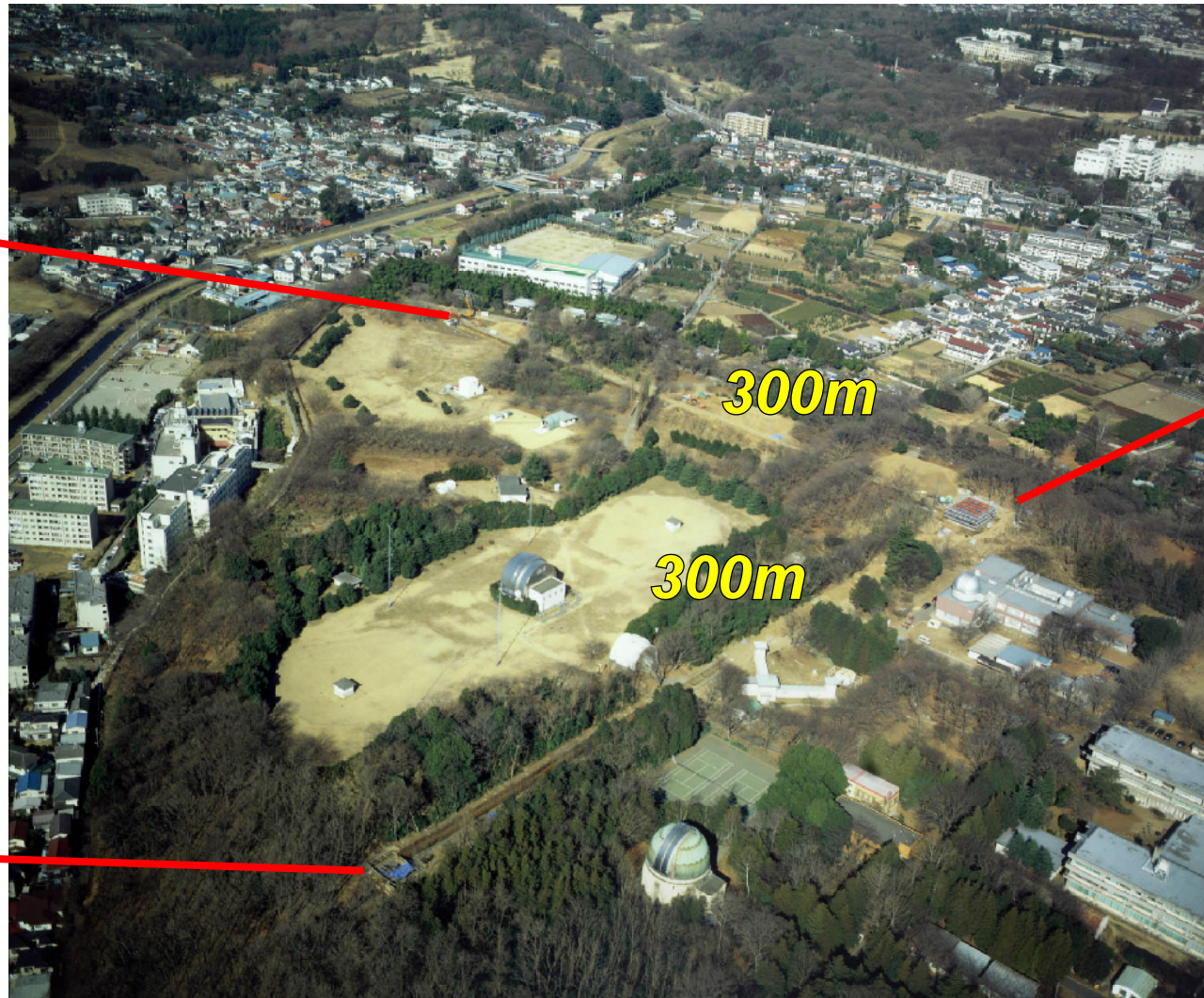

***Middle of a city area ~ heavy traffic***

# TAMA300 detector ~ overview

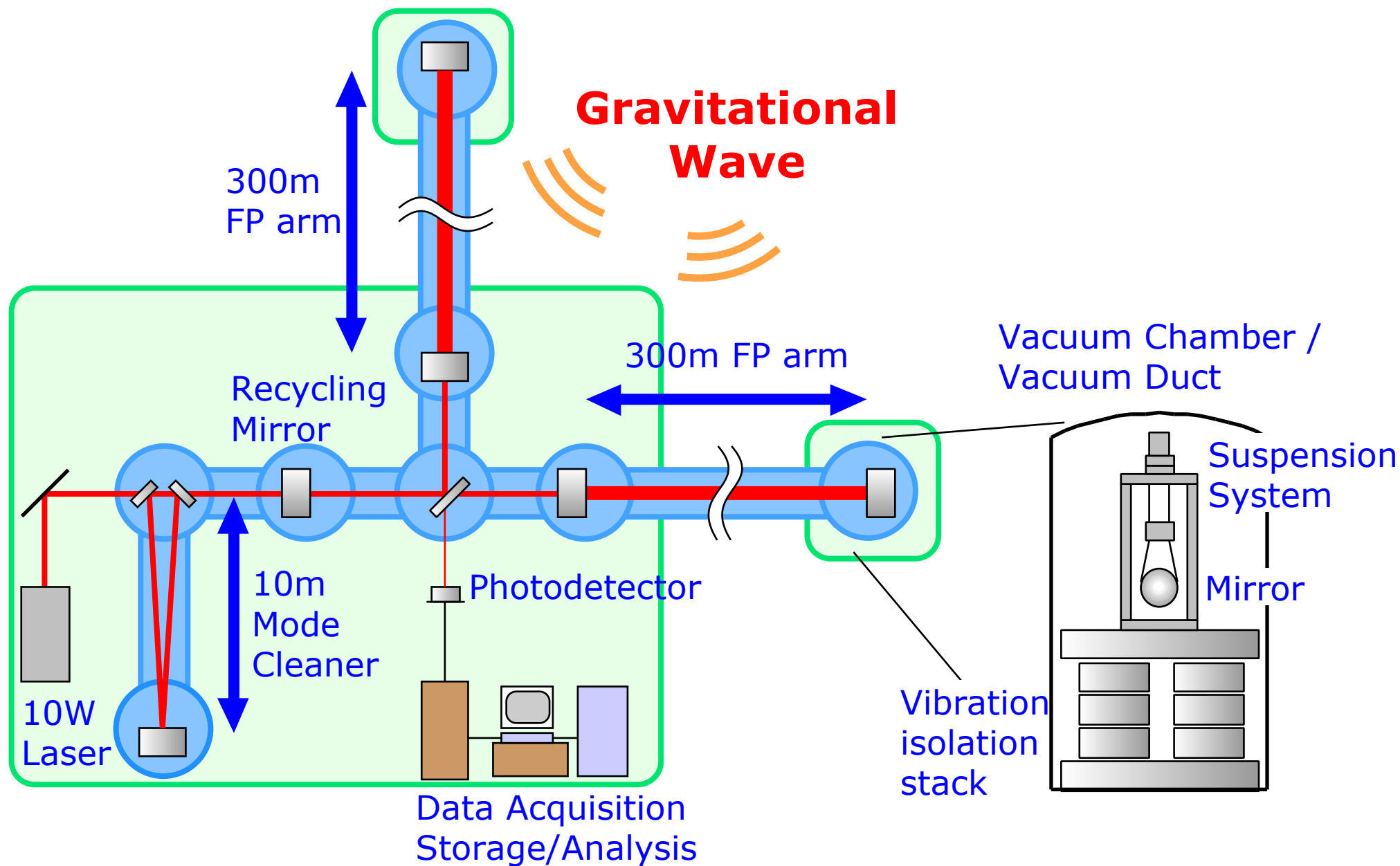

# *Center room*

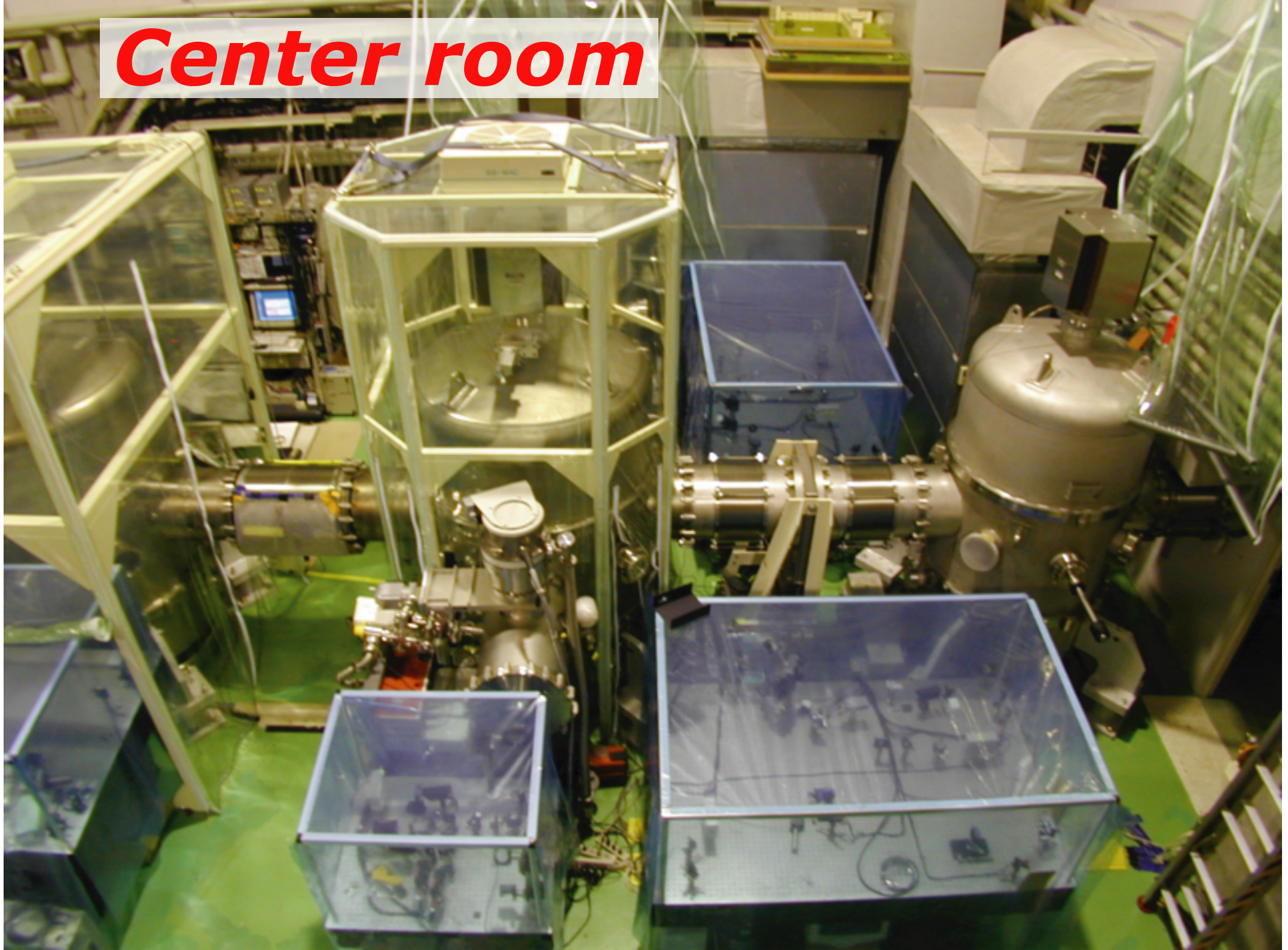

# ***300m vacuum tube***





# Vibration Isolation System



- **3 layer system**

Actively-controlled  
air spring

+

Stack

(Sandwiches of rubbers  
and metal blocks)

+

Double pendulum  
suspension

Achieved performance

~ better than  $10^{-8}$

at 150Hz

# Mirror

- Fused silica ( $\text{SiO}_2$ )  $\phi$  100mm x 60mm

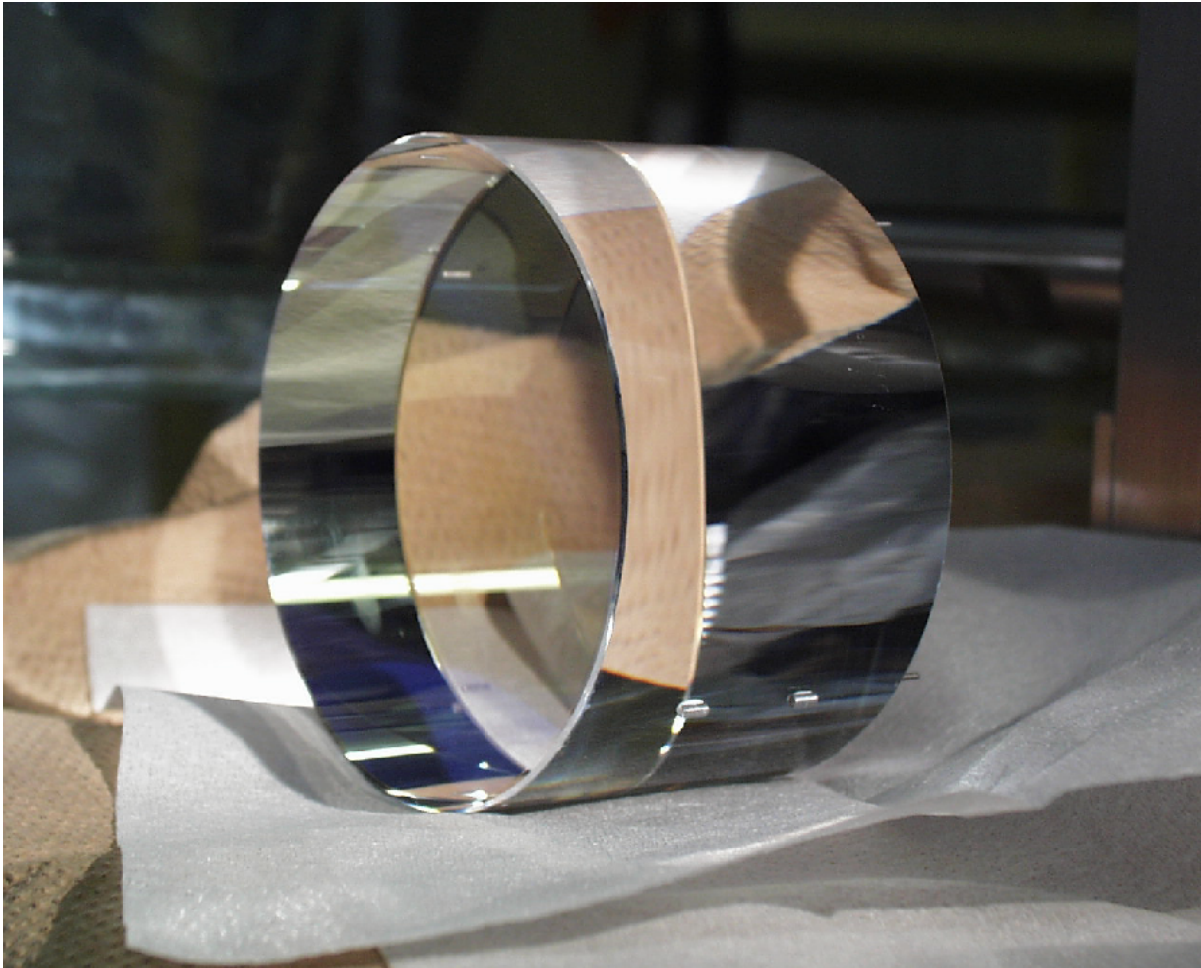

## **Mechanical quality**

Intrinsic  $Q \sim 3 \times 10^6$

## **Optical quality**

substrate absorption

□ 3ppm/cm

total loss in reflection

□ 30ppm

figure error

□  $< \lambda/40$

surface roughness

□  $< 1 \text{ \AA}$

# *Control electronics*

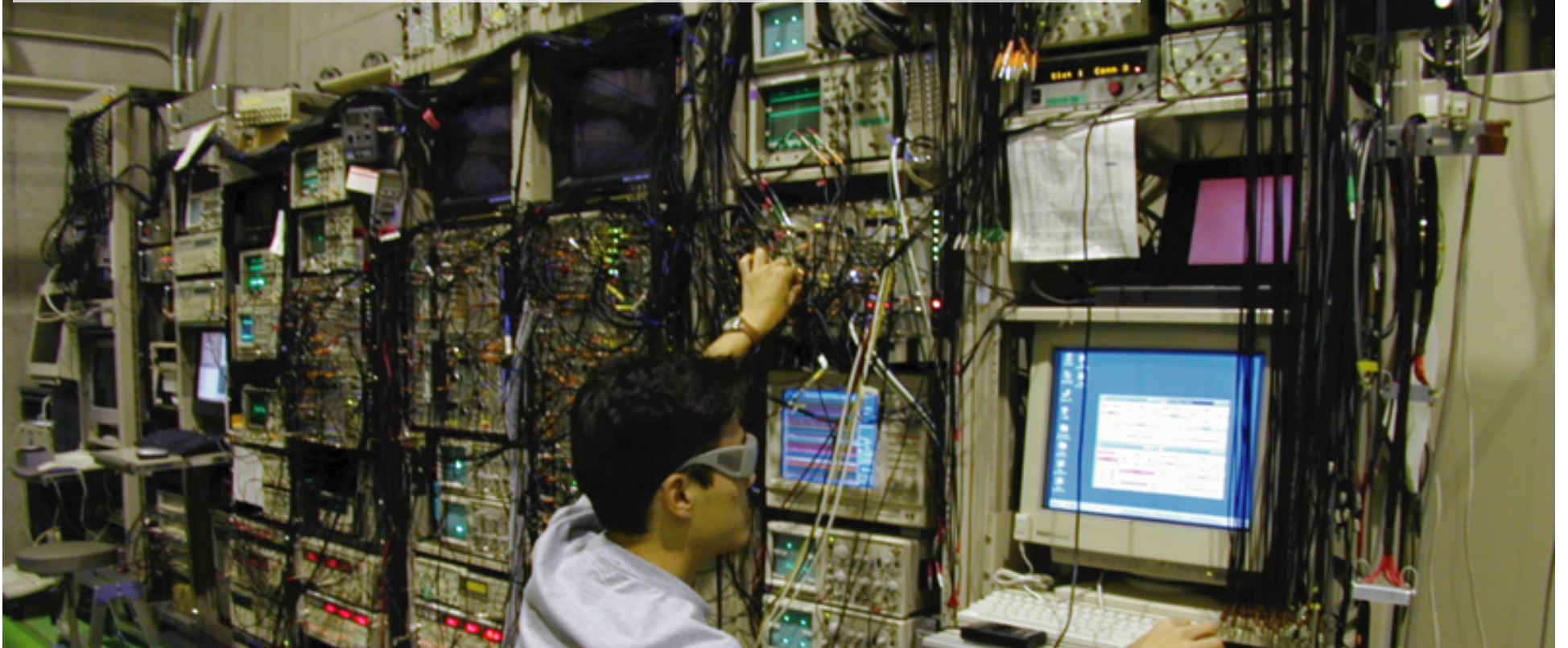

- o Analog servo circuits for the most systems
- o Digital control/switching capability
  - of the analog circuits for automatic lock
- o Several digital servos

# Data Acquisition System

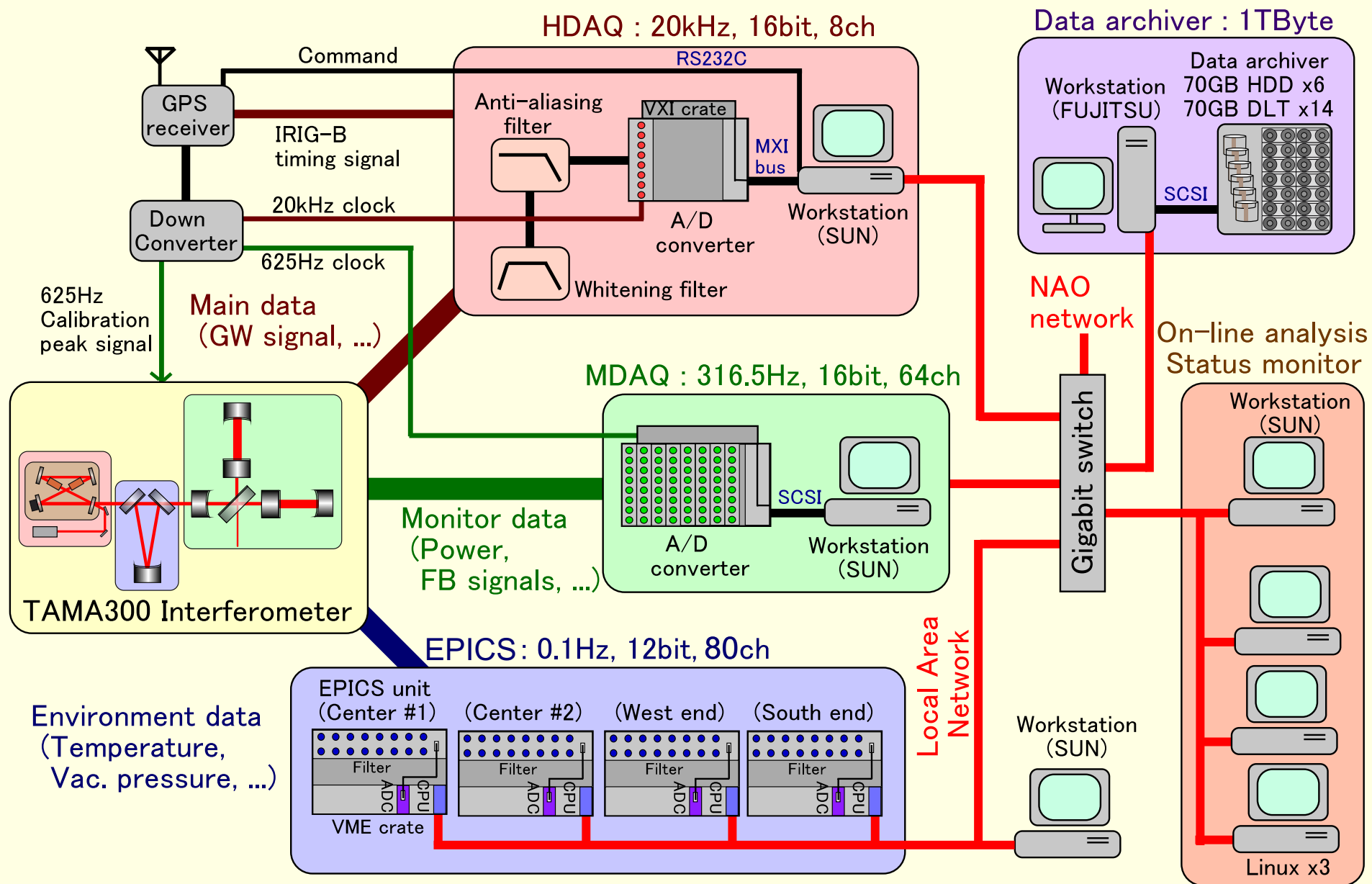

# History of TAMA development

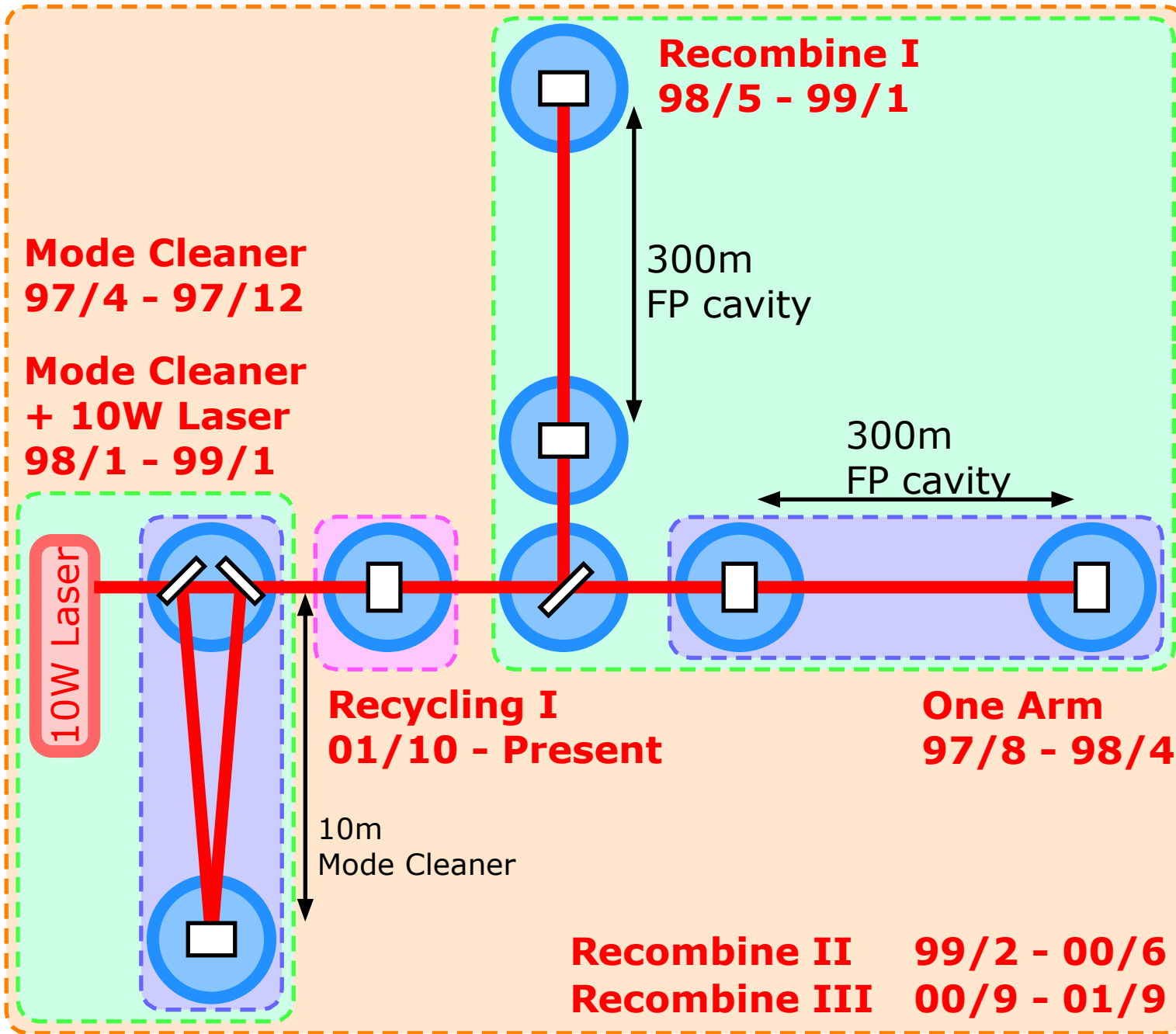

1995	Project started
1996	Facility construction completed
1997	Vacuum system completed
1999/8	Data Taking 1 11h
1999/9	Data Taking 2 31h
2000/4	Data Taking 3 13h
2000/8, 9	Data Taking 4 167h
2001/3	Data Taking 5 111h
2001/8, 9	Data Taking 6 1038h
2001/10-	Recycling experiment
2002/8-9	Data Taking 7 25h
2003/2-4	Data Taking 8 1158h

# ***Data taking (DT) runs in past***

***6 observations without power recycling***  
***2 observations with power recycling***

## **[Without power recycling]**

DT1	1999 Aug.	6~ 7	1 night	11 hours
DT2	1999 Sep.	17~20	3 nights	31 hours
DT3	2000 Apr.	20~23	3 nights	13 hours
DT4	2000 Aug.	21~Sep. 4	13 nights	167 hours
DT5	2001 Mar.	2~ 8	6 days	111 hours

***DT6 2001 Aug. 1~Sep. 20 50 days 1038 hours LISM(20m)***

## **[With power recycling]**

***DT7 2002 Aug, 31~Sep. 2 1 day 25 hours LIGO & GEO***

***DT8 2003 Feb. 14~Apr. 15 59 days 1158 hours LIGO***

# Overview of this talk

- **Introduction of TAMA300**

*a 300-m Fabry-Perot Michelson interferometer  
8 observations in past*

- **The 6th observation: Data Taking 6**

*The observation for 50 days in the summer of 2001  
Analyses of the 1038-hours data*

- **The 8th observation: Data Taking 8  
(= LIGO S2)**

*LIGO-TAMA joint observation for 2 months  
Detector development for DT8  
Operational status*

# Interferometer on DT6

- DT6 ~ 50 days run (2001/8/1~9/20)
- ◆ IFO configuration: Fabry-Perot Michelson (w/o power recycling)
- ◆ Enough sensitivity to detect Galactic merger events
- ◆ Enough stability for long term operation

~ high duty ratio, auto lock-acquisition

Total lock time      1107 h      (92.3%)

Total obs. data (excl. after-lock adj.)  
                                 1038 h      (86.5%)

- ◆ Coincidence with LISM 20m IFO at Kamioka mine

Lock overlapping      709 h      (59.1%)

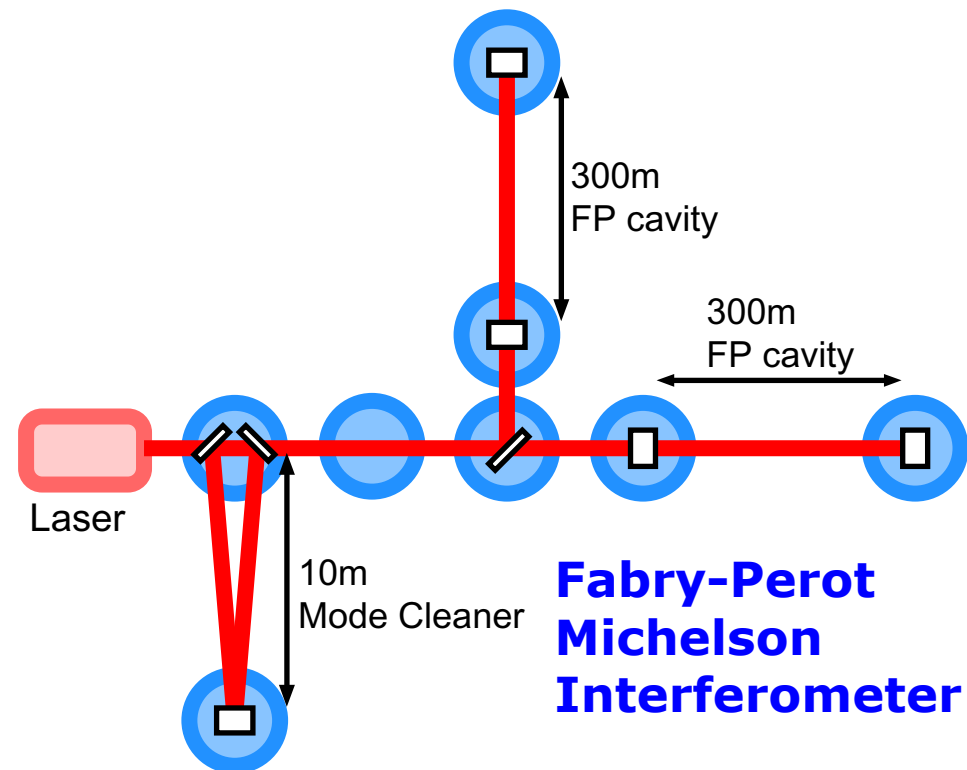



# Sensitivity of IFO at DT6

- Displacement noise  $dx = 1.5 \times 10^{-18} \text{ m/Hz}^{1/2}$  (@700Hz)  
Strain sensitivity  $\square \quad h = dx/300$   
 $= 5 \times 10^{-21} / \text{Hz}^{1/2}$

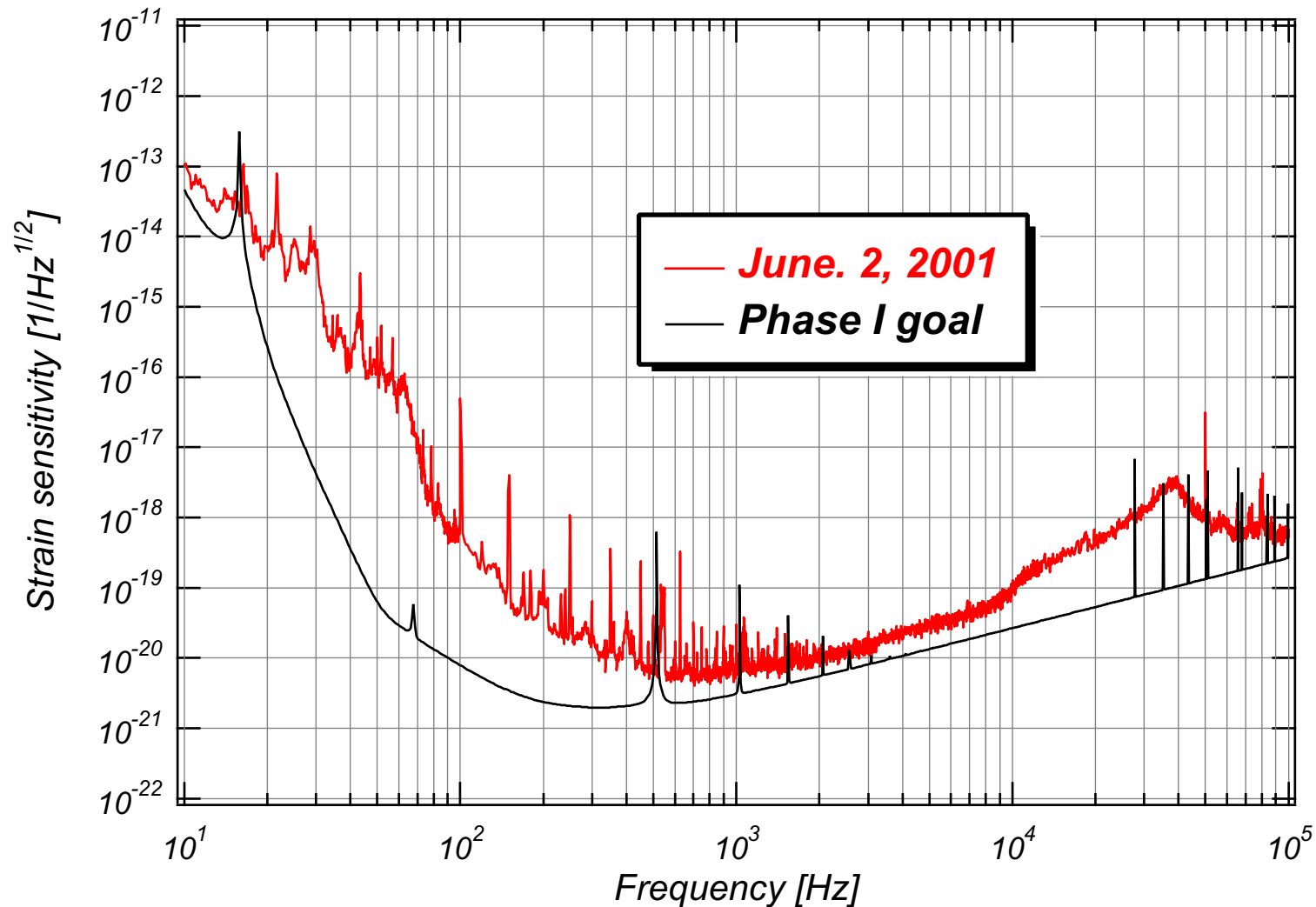

Binary Range:  
33kpc

(Distance to  
observe  
NS inspirals  
with SNR=10)

# ***DT6 data analysis***

- ***Binary inspiral search***

Matched filtering search (1~2Msolar)

Coincidence analysis

between TAMA and LISM20m (1~2Msolar)

- ***Burst search***

Non-Gaussianity detection using higher-order stat.

- ***Periodic GW search***

Possible GW wave from SN1987a (@~935Hz)

# ***GW search: compact binary inspirals***

## ● ***Matched filtering analysis***

Upper limit to the galactic event rate:

	Revent [h]	Revent [/y]	Dobs [kpc]	Tobs [h]
DT2:	0.59 /h	$=5.2 \times 10^3$ /year	3.4kpc	31h
DT4:	0.027 /h	$=2.4 \times 10^2$ /year	17.9kpc	167h
DT6:	0.0095/h	$=8.3 \times 10^1$ /year	33.1kpc	1038h

# Matched Filtering analysis

- Detector outputs:  $s(t) = Ah(t) + n(t)$   
 $h(t)$  : known gravitational waveform (2.5PN template)  
 $n(t)$  : noise.
- Correlation of the detector output and the template in the frequency domain:

$$\rho(m_1, m_2, t_c, \dots) = 2 \int \frac{\tilde{s}(f) \tilde{h}^*(f)}{S_n(f)} df$$

- Weighted by  $S_n(f)$  noise spectrum density
- Signal to noise ratio  $\text{SNR} = \rho / \sqrt{2}$
- Find the optimal parameters  
 $m_1, m_2, t_c, \dots$   
in a data chunk which maximizes  $\rho$

## $C^2$ test

Divide frequency region into bins.

Test whether the contribution to  $\mathbf{r}$  from each bin agrees with that expected from chirp signal

$$\mathbf{r} \equiv (s, h) \left( = 2 \int \frac{\tilde{s}(f) \tilde{h}^*(f)}{S_n(f)} df \right)$$

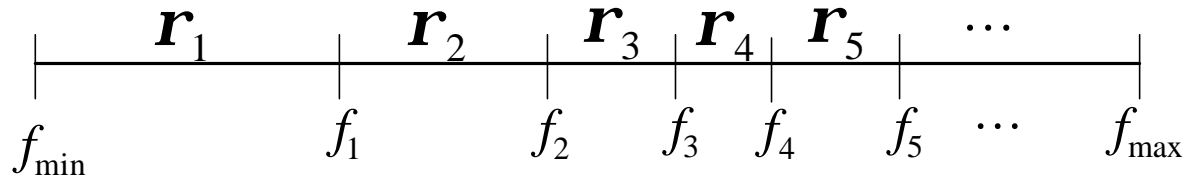

$$c^2 \equiv \sum \frac{1}{s_i^2} (\mathbf{r}_i - \bar{\mathbf{r}}_i)^2$$

$$s_i^2 \equiv \langle (\mathbf{r}_i - \bar{\mathbf{r}}_i)^2 \rangle, \quad \bar{\mathbf{r}}_i = \langle \mathbf{r}_i \rangle$$

# Performance of $r/\sqrt{c^2}$ selection

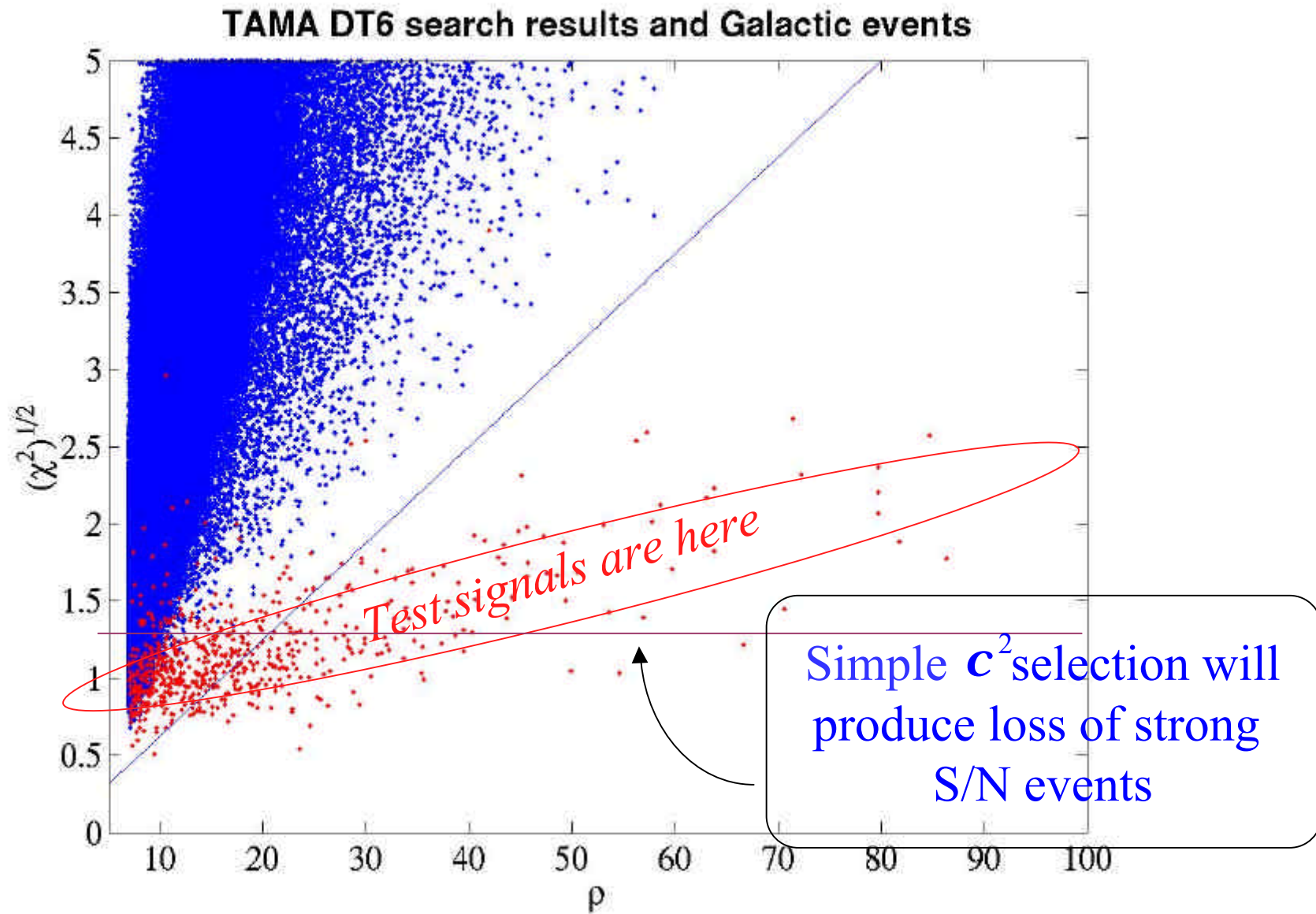

# Upper limit to the Galactic event rate

threshold=16 (  $\sim$  S/N=11) (fake event rate=0.8/year)

Efficiency for Galactic events  $\epsilon = 0.23$  (from simulation)

•We also obtain upper limit to the average number of events over threshold by standard poisson statistics analysis

→  $N=2.3$  (C.L.=90%)

•Data length used :  $T = 1039$  hours

→ Upper limit to the Galactic event rate

$$= \frac{N}{T\epsilon} = 0.0095 \text{ [1/hour]} \text{ (C.L. = 90\%)}$$

# Location of TAMA and LISM

	orientation	latitude	longitude
TAMA	225 °	35.68 ° N	139.54 ° E
LISM	165 °	36.25 ° N	137.18 ° E

- Distance between TAMA and LISM ~ 220km
- **Maximum delay of signal arrival time ~ 0.73msec**
- Relation between TAMA and LISM arms direction

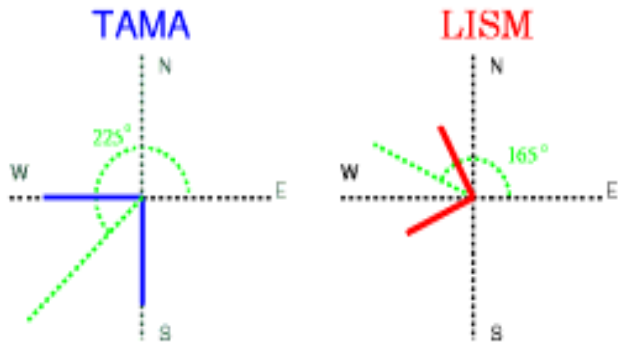
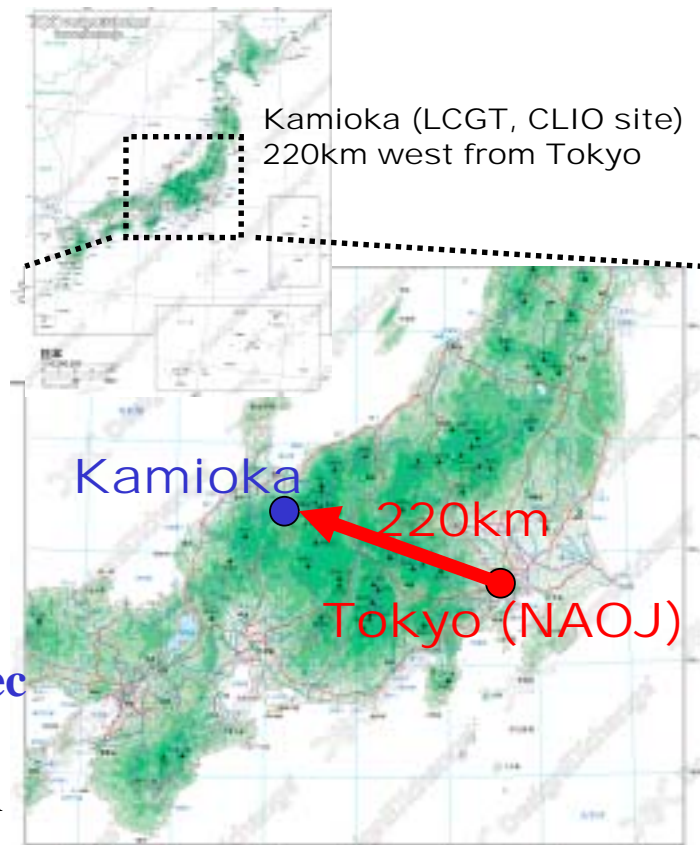



## Results of coincident event search

Results of onestep search for common lock parts

TAMA

158437 events

LISM

142465 events

After  $t_c$ -coincidence  
70 events

After  $t_c, M, \eta$ -coincidence  
18 events

After  $t_c, M, \eta, \rho$ -coincidence  
13 events

## Results of coincident event search

### Results of onestep search for common lock parts

TAMA  
158437 events

LISM  
142465 events

After  $t_c$ -coincidence  
70 events

accidental coincidence  $(\bar{n}_{acc} \pm \sigma_c)$   
70.45  $\pm$  8.53

After  $t_c, M, \eta$ -coincidence  
18 events

accidental coincidence  $(\bar{n}_{acc} \pm \sigma_c)$   
17.55  $\pm$  4.08

After  $t_c, M, \eta, \rho$ -coincidence  
13 event

accidental coincidence  $(\bar{n}_{acc} \pm \sigma_c)$   
12.76  $\pm$  3.51

## Coincident event search upper limit (4)

From above figure, we set threshold for each detector,

$$\text{TAMA threshold : } \rho_{tama} / \sqrt{\chi_{tama}^2} = 6.2$$

$$\text{LISM threshold : } \rho_{lism} / \sqrt{\chi_{lism}^2} = 5.3$$

Observed number of events over threshold: Nobs=0

Expected number of fake events over threshold:  $N_{bg}=0.72$



We can obtain **the average number of events over threshold N=2.3 (C.L.=90%)**

- The second, we evaluated **detection efficiency**

we performed a Galactic event simulation (within 1kpc) .

Setting above thresholds, we can obtain the probability that we observe events over the each detector's threshold (**namely detection efficiency**)  $\longrightarrow$  **= 0.22**

- Length of data : **T=244 hours**

**TAMA + LISM case**

**Upper limit to the Galactic (within 1kpc) event rate :**

$$\mathbf{N/T = 0.042 \text{ events/hour (C.L. 90\%)}}$$

# Burst wave analysis (2)

--- Reduction of non-stationary noise ---



- **Non-Gaussian noise reduction**

Distinguish GW signal from non-Gaussian noises  
with time-scale of the **'unusual signals'**

→ **GW from gravitational core collapse < 100 msec,**  
**Noise caused by IFO instability > a few sec**

- **2 statistics in detector output**

- **Averaged noise power**

- **2<sup>nd</sup>-order moment of noise power**



**Estimate parameter : 'GW likelihood'**

$$C_1 = \langle P_j \rangle$$

$$C_2 = \frac{1}{2} \left( \frac{\langle P_j^2 \rangle}{\langle P_j \rangle^2} - 2 \right)$$



**Reduce non-stationary and non-Gaussian noises  
without rejecting GW signals**

# Burst wave analysis (3)

--- Data processing ---



## • Data Processing

1. Calculate **Spectrogram** by FFT
2. Extract a certain **time-frequency region** to be evaluated
3. Evaluate **GW likelihood** at each frequency
4. **Reject given time region** if it has large 'non-GW like' ratio
5. Calculate **total power** for given T-F region



## • 'Filter' outputs

Survived --- Stable detector operation

Data may be used for GW search

Large power : **event candidates**

Rejected --- Detector instability

Detector '**dead time**'

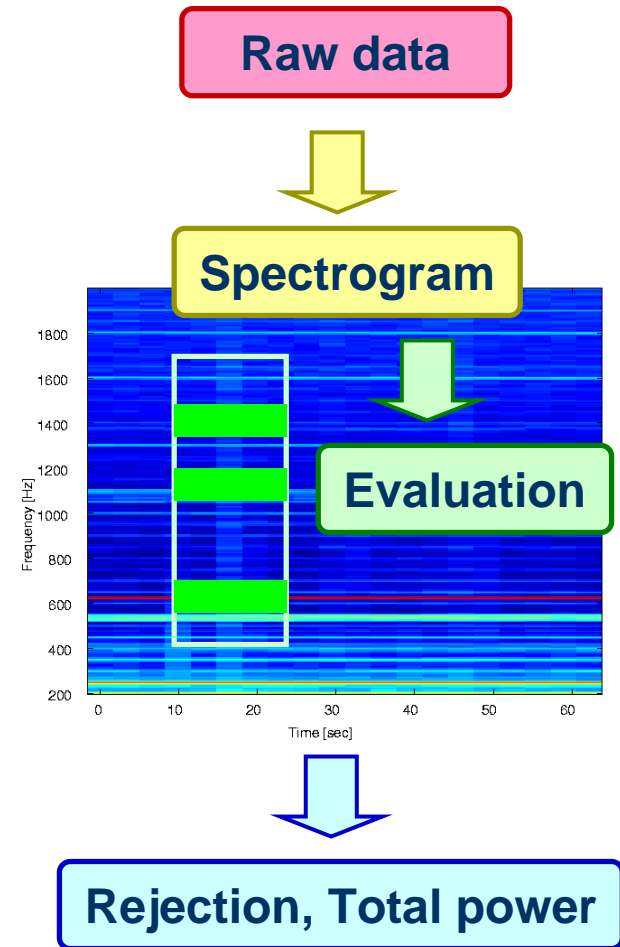

# Burst wave analysis (4)

--- DT6 data analysis ---



- Data Taking 6 (Summer 2001)

- Bandwidth : 500Hz

Rejected data : 10%

(False dismissal rate : 1ppm)



Improvement of

false event rate : 1/1000

- Still worse than stable hours in DT4, and Gaussian noise level



- Event rate for 10msec GWs

- $h_{\text{rms}} \sim 1 \times 10^{-17}$  : 1 events/hour

- $h_{\text{rms}} \sim 3 \times 10^{-17}$  :  $10^{-2}$  events/hour

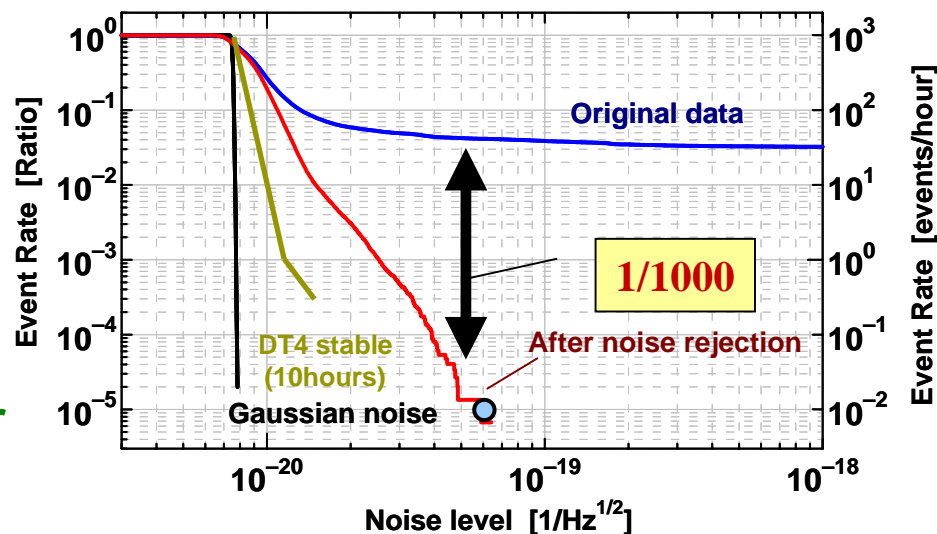
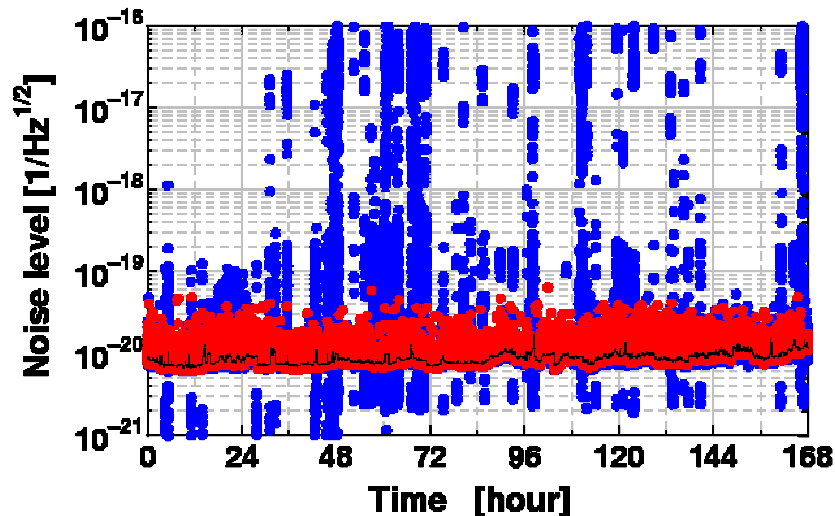

# Continuous wave from SN1987A

- **Target: possible SN1987a remnant**

(Middleditch, et al. New Astronomy, 5 (2000) 243)

- **Expected Waveform: Sinusoidal** ( $f=934.908\text{Hz} \pm 0.05\text{Hz}$ )

- + time dependence of the sensitivity

- + doppler correction

- (the earth's daily/yearly round)

- + spindown correction

- (assume spindown rate:  $2\sim 3 \times 10^{-10}$  [Hz/s])

- **Search result: DT6 50days data**

Time-domain search:  $h=3.8 \times 10^{-23}$  (False Alarm: 1.8%)

Frequency domain search:  $h=4.1 \times 10^{-23}$  (False Alarm: 1.8%)

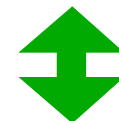

( $h_{\text{upperlimit}}$  from the spindown:  $h=9.4 \times 10^{-27}$ )

# Overview of this talk

- **Introduction of TAMA300**

*a 300-m Fabry-Perot Michelson interferometer  
8 observations in past*

- **The 6th observation: Data Taking 6**

*The observation for 50 days in the summer of 2001  
Analyses of the 1038-hours data*

- **The 8th observation: Data Taking 8  
(= LIGO S2)**

*LIGO-TAMA joint observation for 2 months  
Detector development for DT8  
Operational status*



# Data Taking 8 (LIGO S2)

## ● DT8 ~ 2 months run (2003/2/14~4/15)

First full-time joint observation with LIGO S2

(c.f. DT7: partial participation of TAMA to S1)

First long-term observation with power recycling

Power recycling of TAMA300 (2001/10~Present)

Power recycling gain of 4.5

Best sensitivity:  $2.7 \times 10^{-21}$   
[ $\text{Hz}^{1/2}$ ]

IFO operation

Accumulated data: 1158 hours

Duty cycle: 81.3 %

Longest lock: 20.5 hours

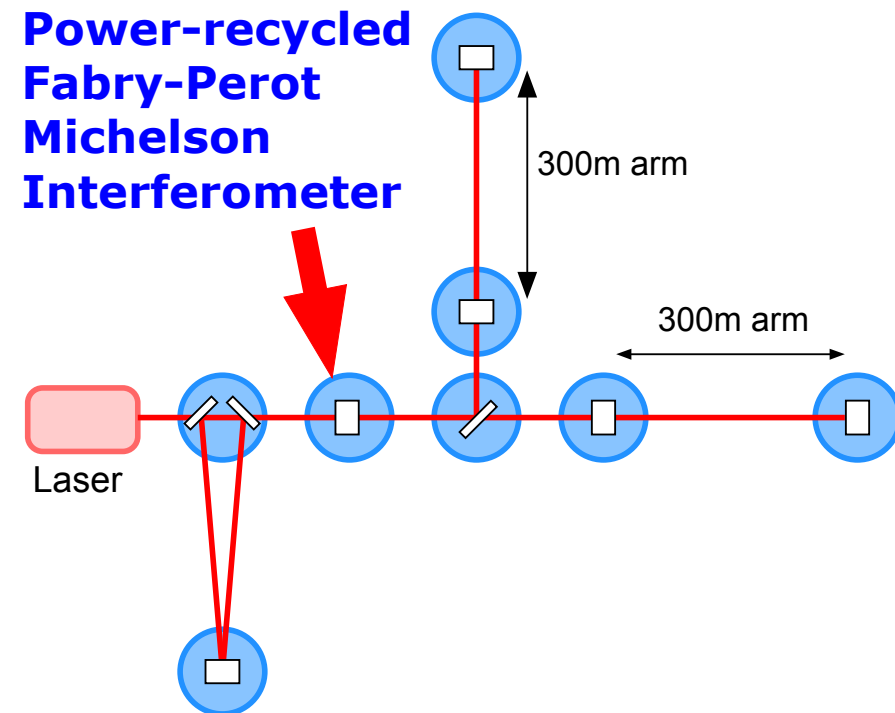

# Principle of power recycling

- Laser light is enclosed in the interferometer

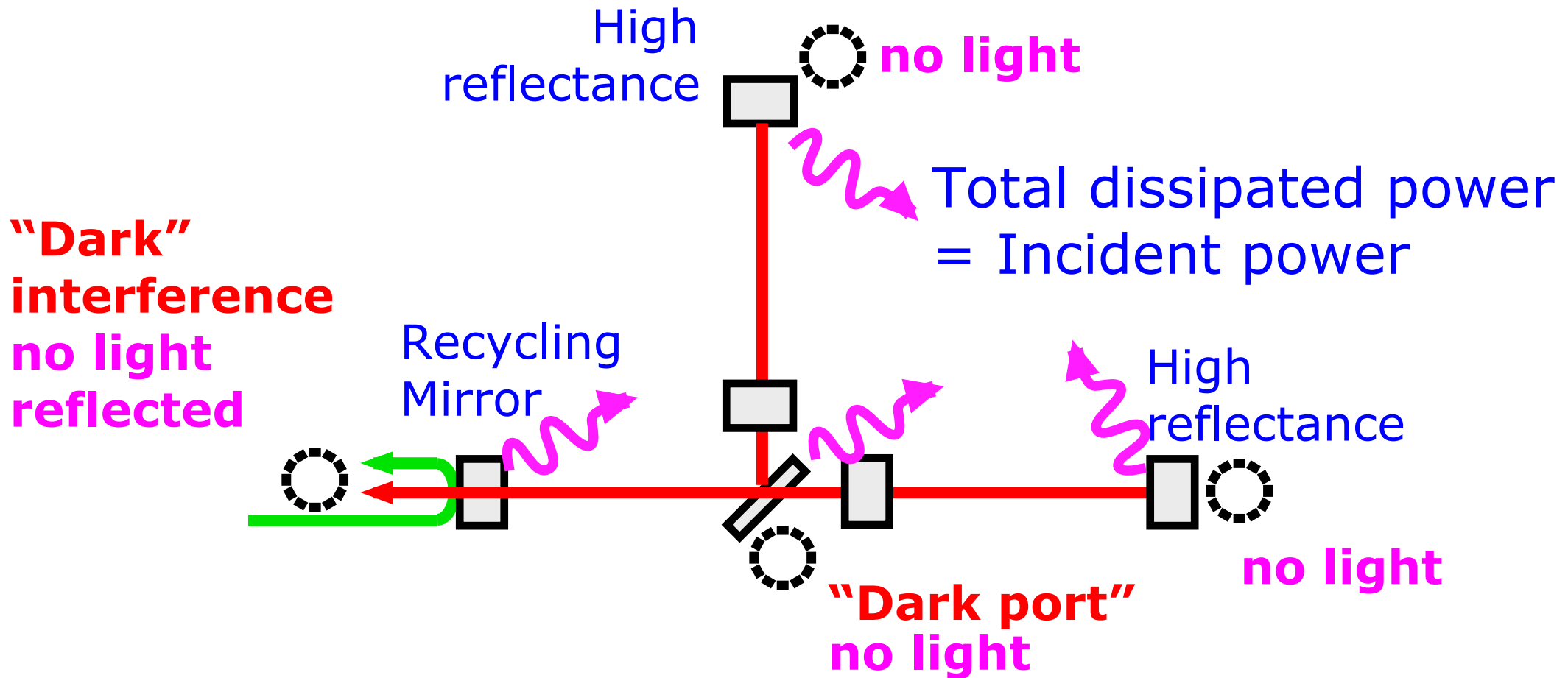

$$P_{\text{inc}} = \epsilon_{\text{loss}} P_{\text{internal}} \rightarrow P_{\text{internal}} = \frac{P_{\text{inc}}}{\epsilon_{\text{loss}}} \equiv g P_{\text{inc}}$$

# ***DT8 ~ IFO development***

## **I Fitting the IFO for DT8**

### **Sensitivity**

- >> Improvement of the detection noise/shot noise level  
by power recycling
- >> Reduction of the frequency noise

### **Stability**

- >> Automatic lock system
- >> Automatic alignment control for 4 test masses,  
recycling mirror, and the mode cleaner mirrors
- >> Optical axis control

# Automatic lock acquisition

## Self-switching sub-systems (Laser&MC)

- MC frequency stabilization
- MC alignment control
- Laser intensity stabilization
- Optical axis control
- Injection lock servo of the laser

## Digital switching using PC and Labview

- Lock acquisition
- Manual mirror alignment
- I/O Status monitoring

Hardware: PC + DAQ board

Software: National Instruments LabVIEW

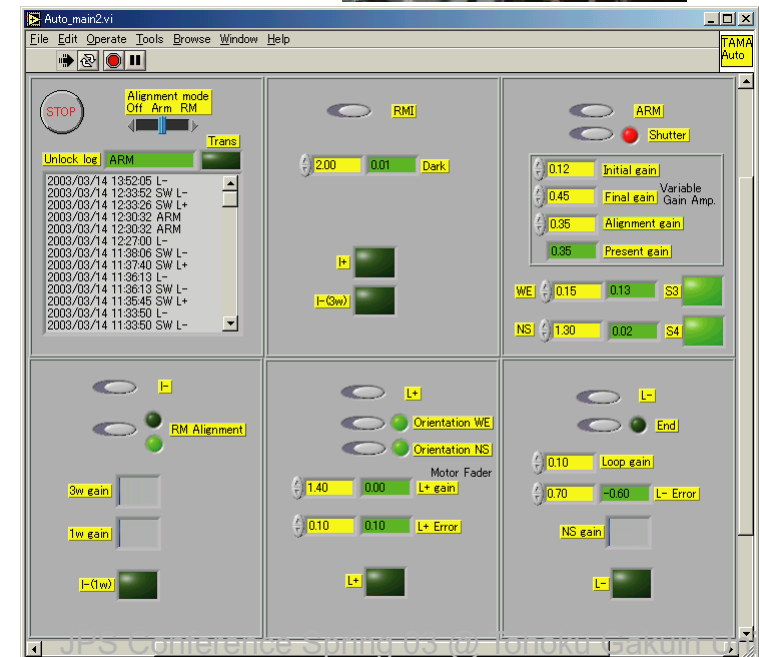

# Optical Config. and control system

- I Length control for lock acq.
- I Alignment control for test mass
- I High S/N length control

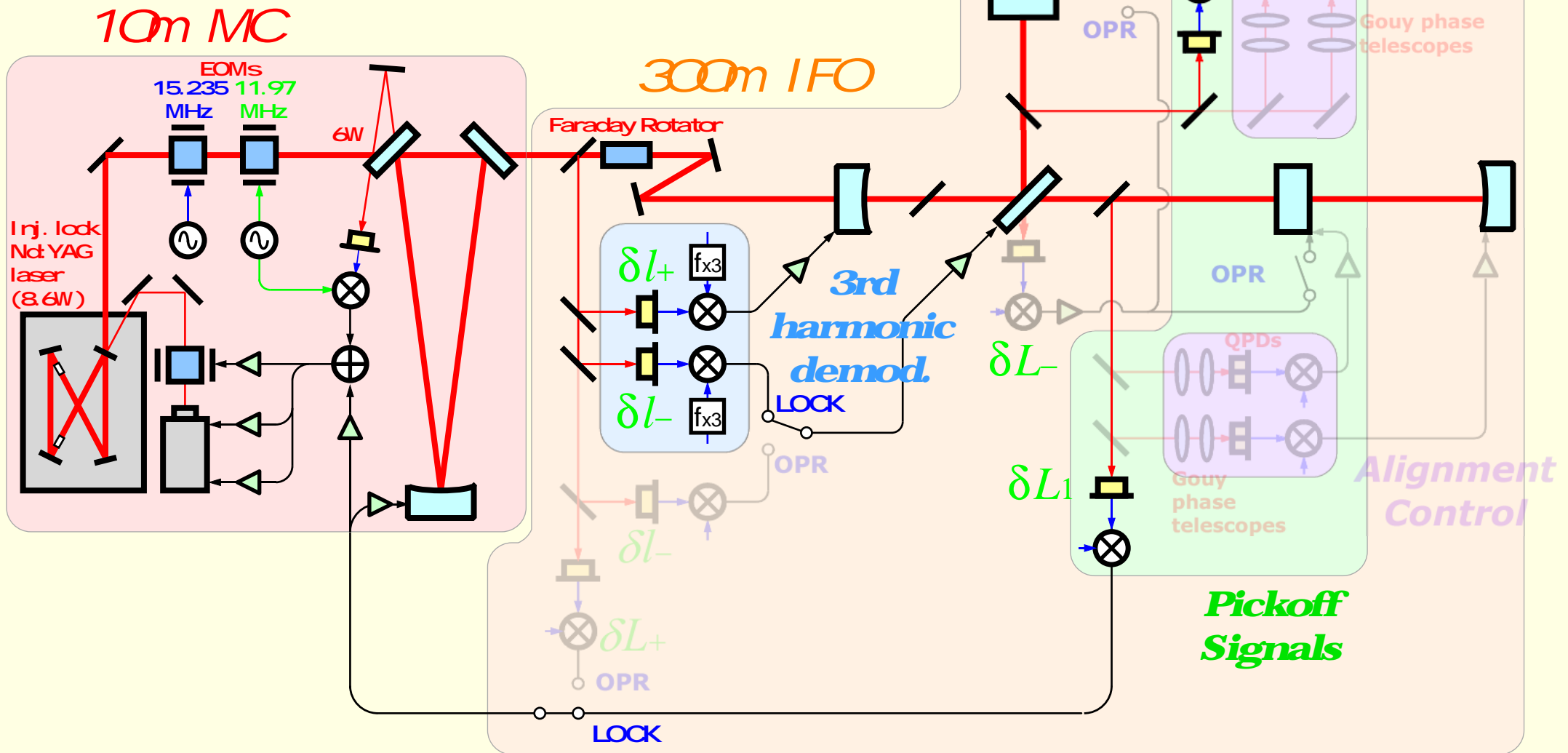

# Optical Config. and control system

- | Length control for lock acq.
- | Alignment control for test mass
- | High S/N length control

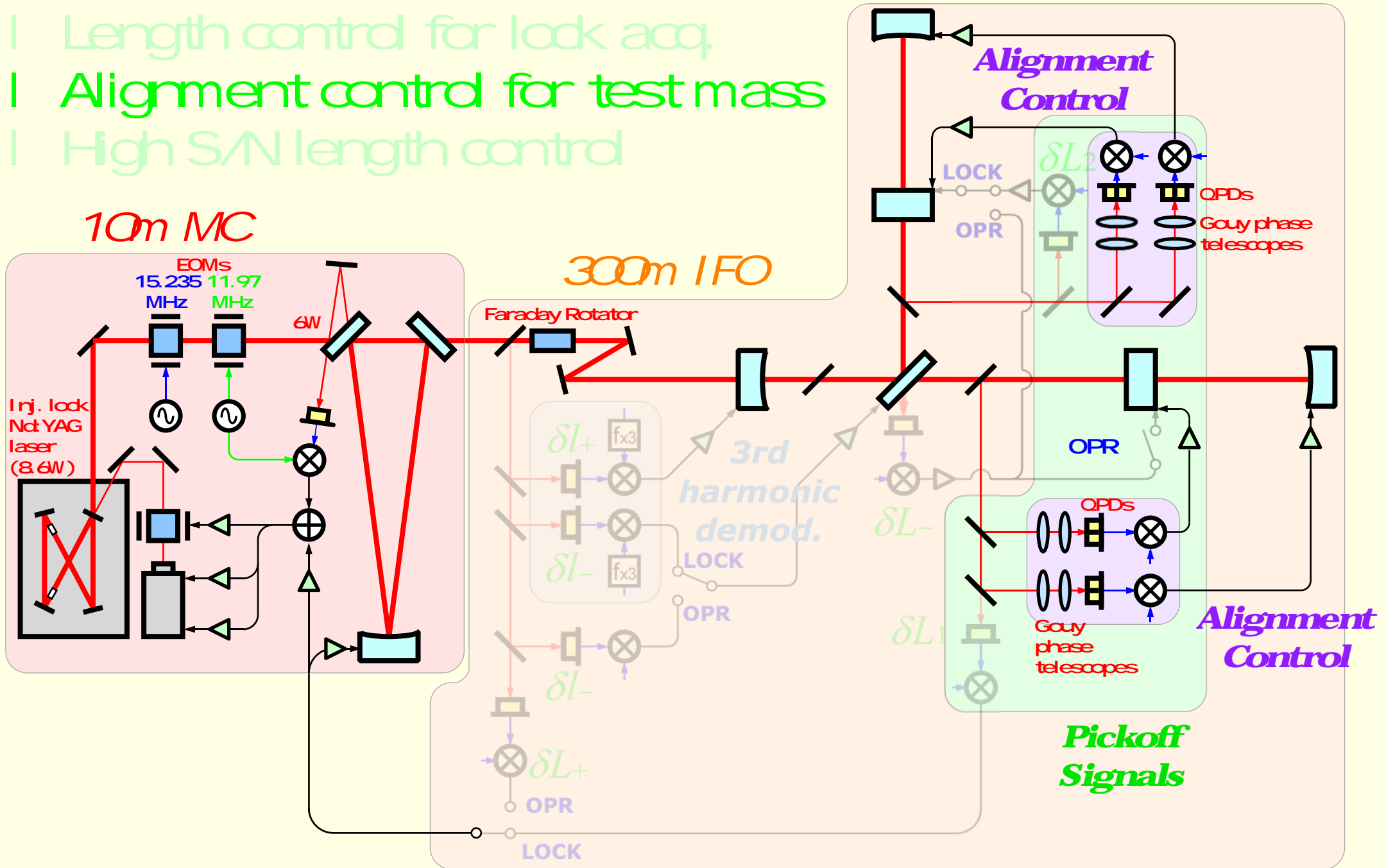

# Optical Config. and control system

- | Length control for lock acq.
- | Alignment control for test mass
- | High S/N length control

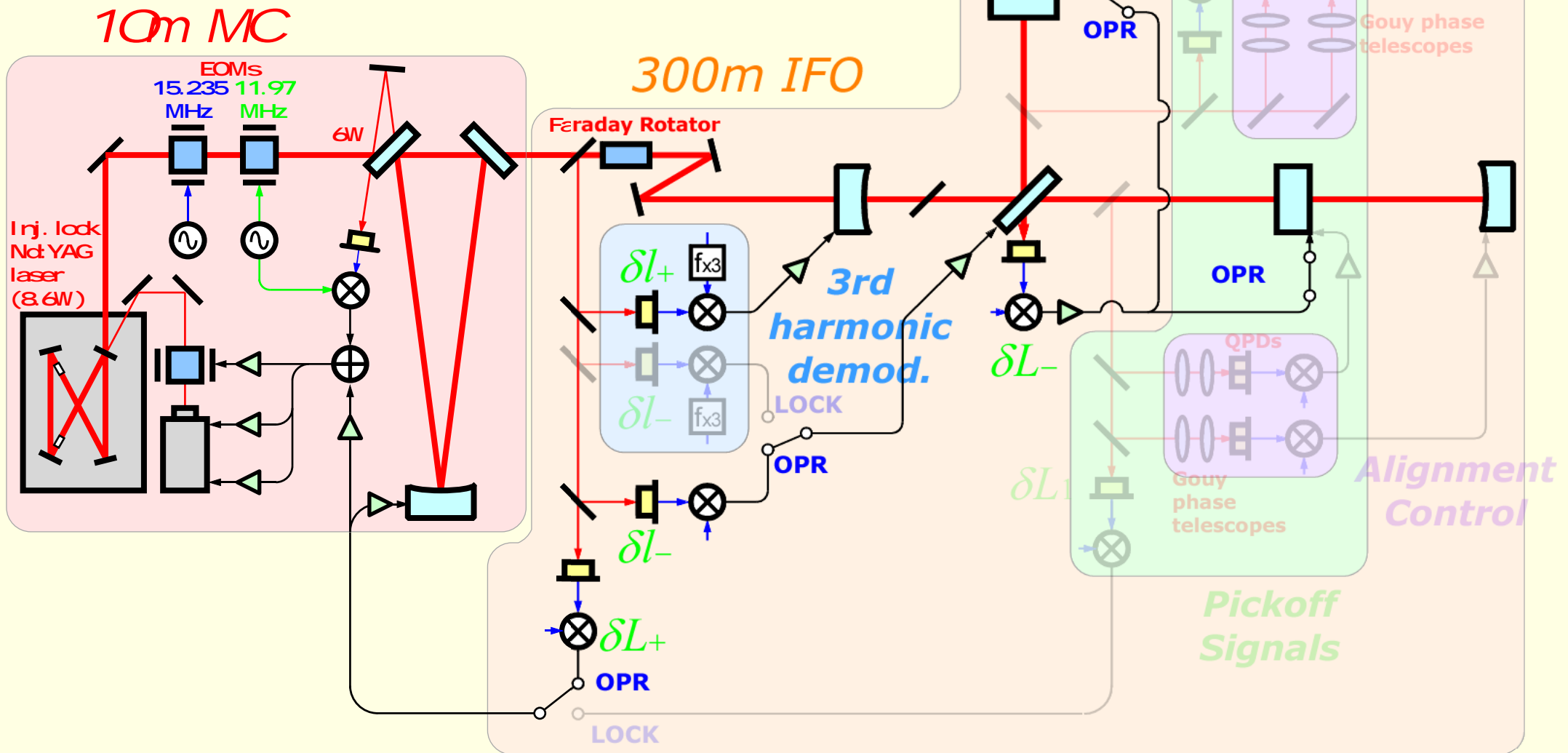

# Alignment control

## Alignment control servo for the recycling mirror

- Mechanical modulation technique (Pitch 60Hz, Yaw 70Hz)
  - Suppress long-term drift => bandwidth < 1Hz
- => All of the five mirrors are controlled

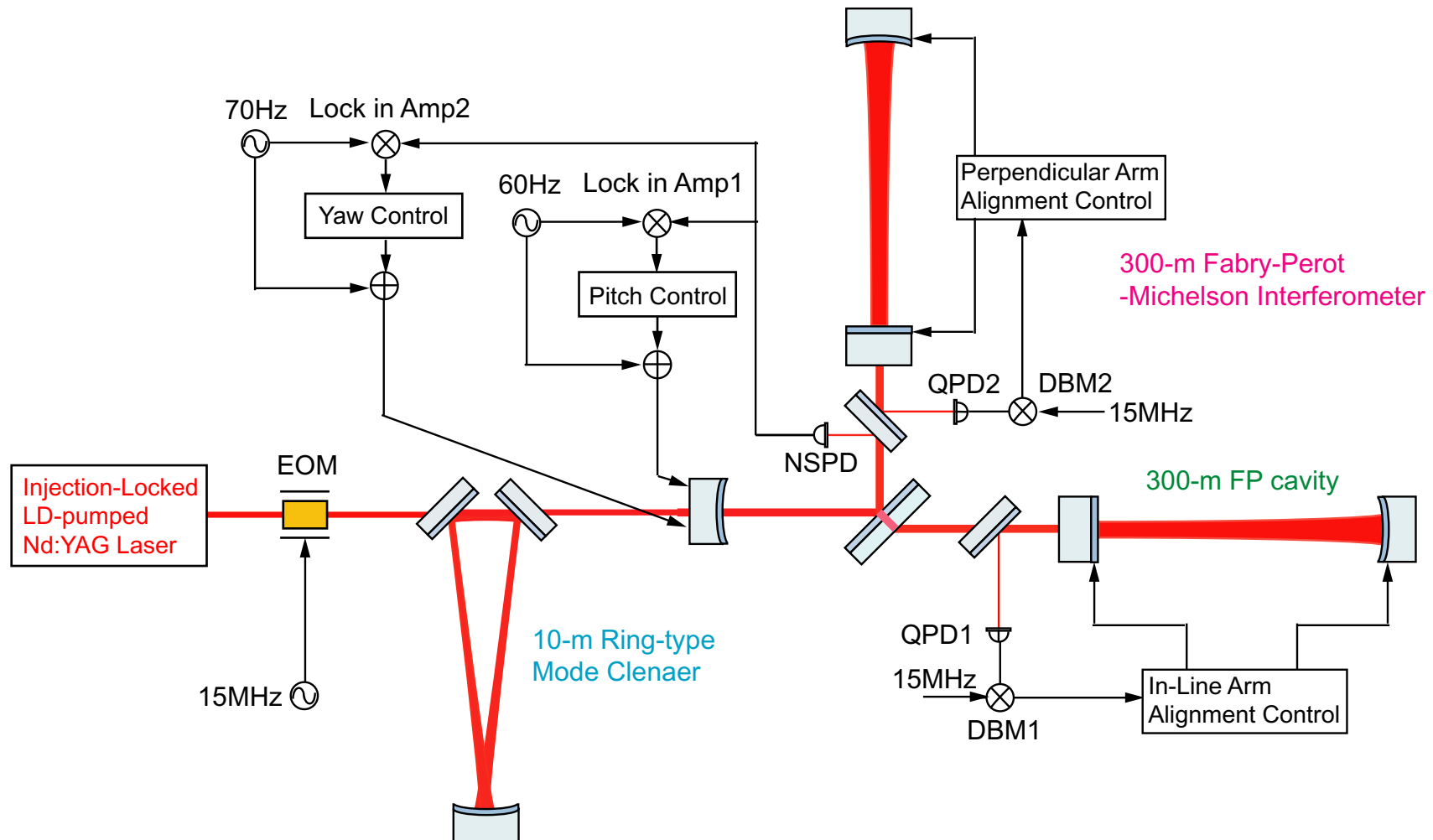



# Stabilizing optical axes

## Control incident beam axis

2 QPDs / 2 PZT mirrors  
on the injection table

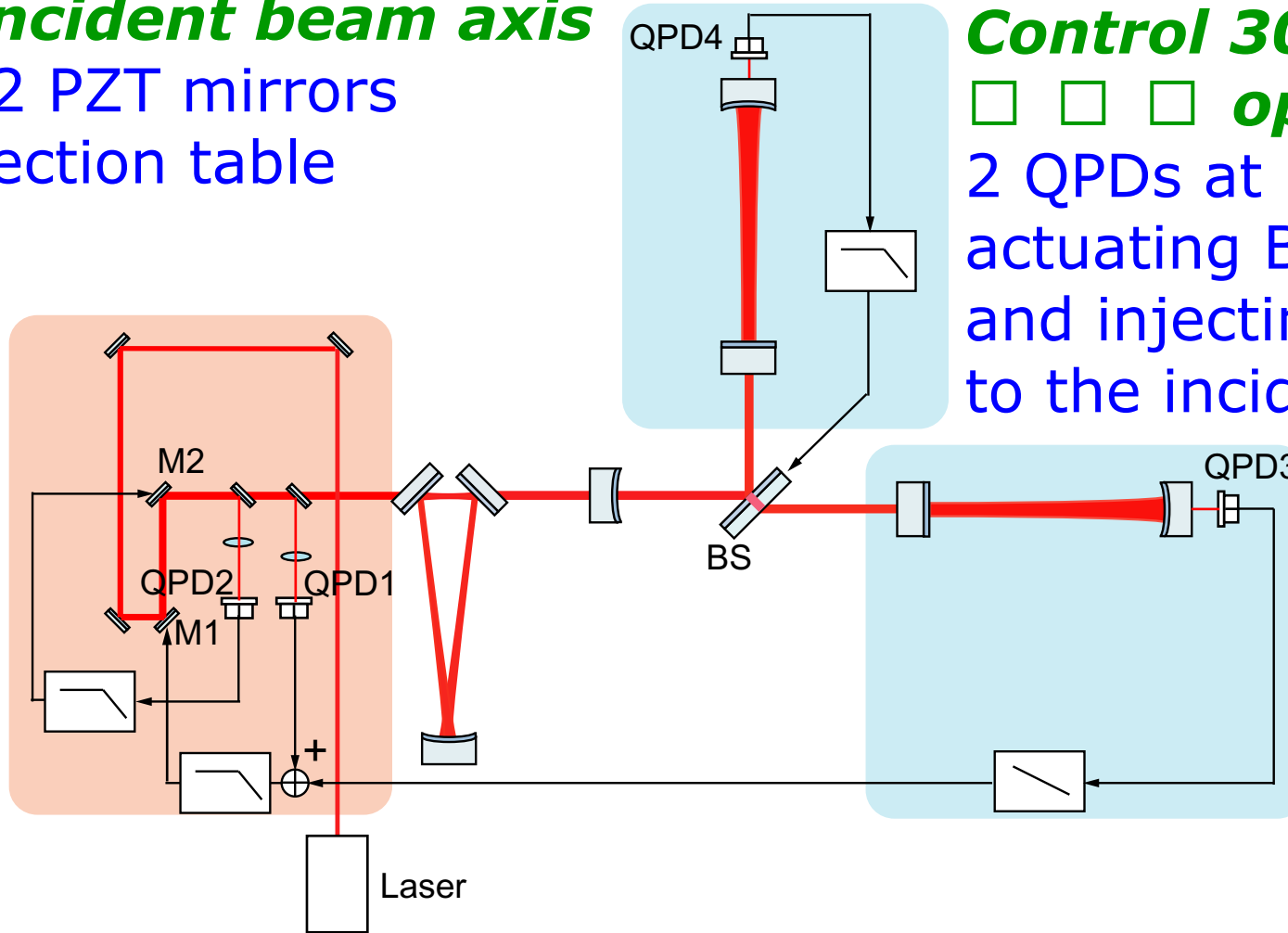

## Control 300-m

□ □ □ **optical axes**

2 QPDs at both end  
actuating BS  
and injecting signal  
to the incident axis servo

- => Minimizing the alignment noise coupling to dL-
- => Improvement of the long-term stability of the main IFO,  
□ □ as well as the long-term stability of the MC.

# *Improved long-term stability*

*Longest lock stretch in the observations*

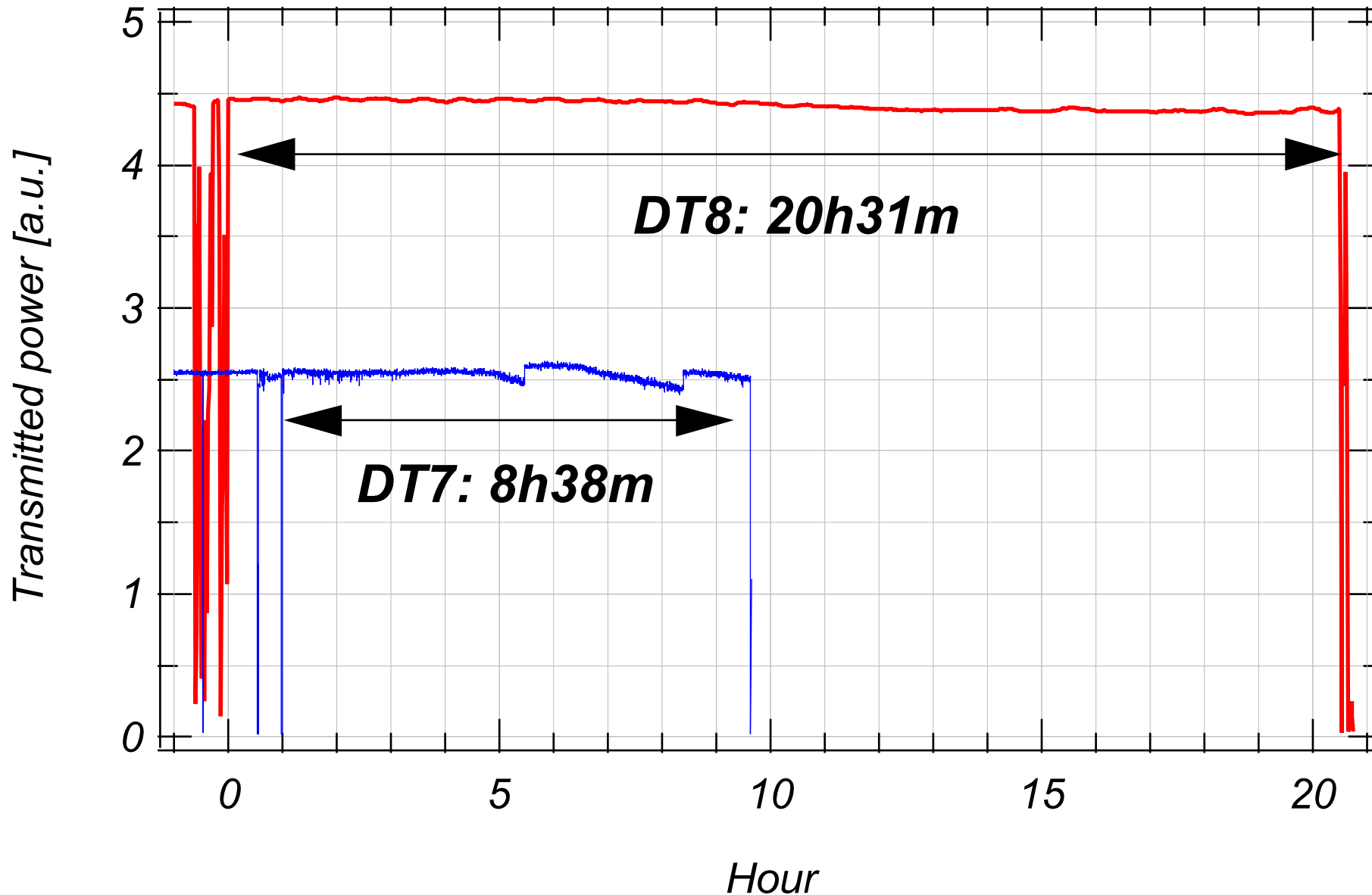

# Frequency Stabilization

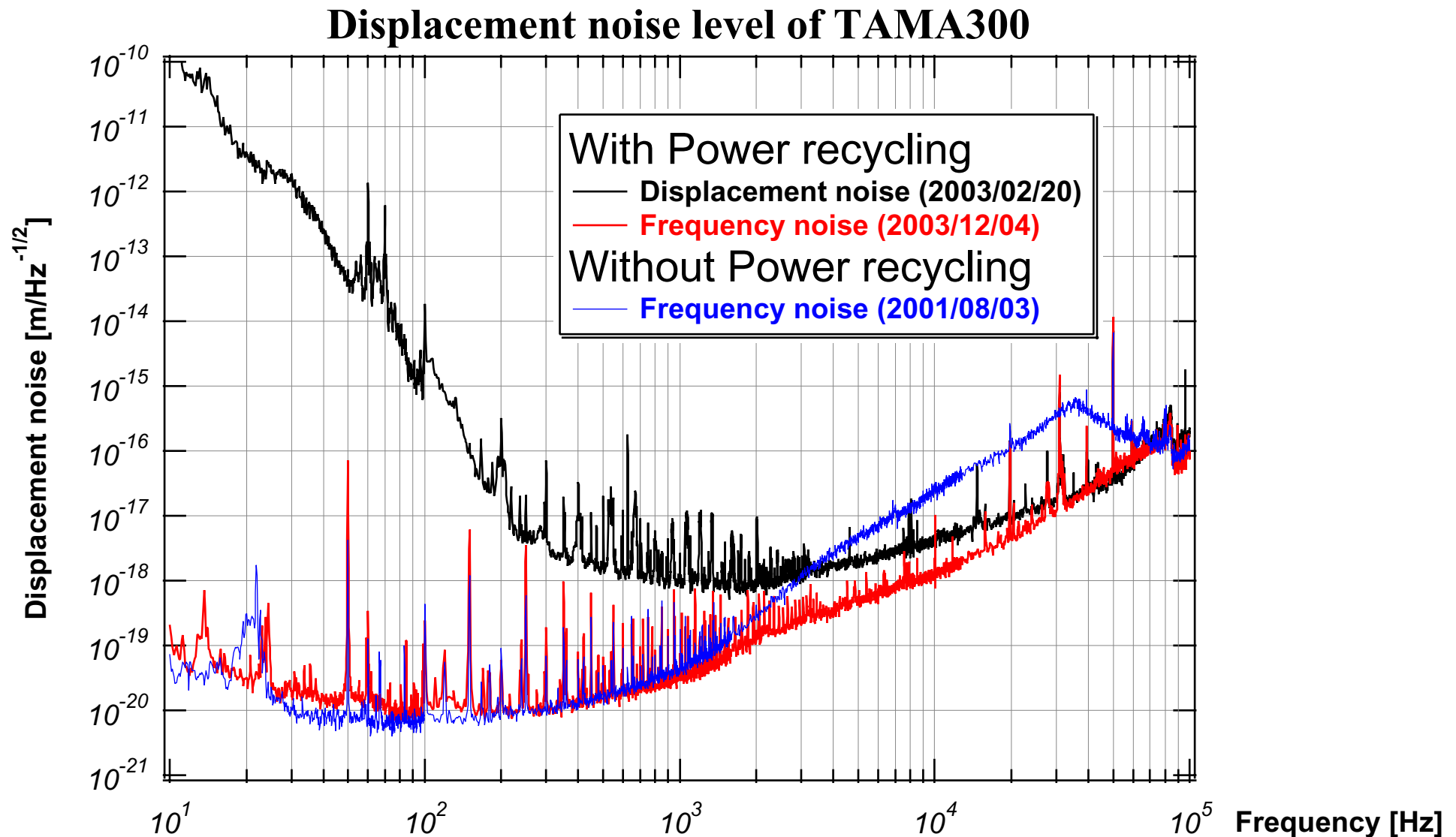

Control bandwidths extended:

- □ MC servo □ □ □ □ (300kHz -> 600kHz)
- □ Common-mode servo □ (□ 20kHz -> 40kHz)

# Sensitivity @ DT8

## Displacement noise level of TAMA300

(Feb, 20 2003)

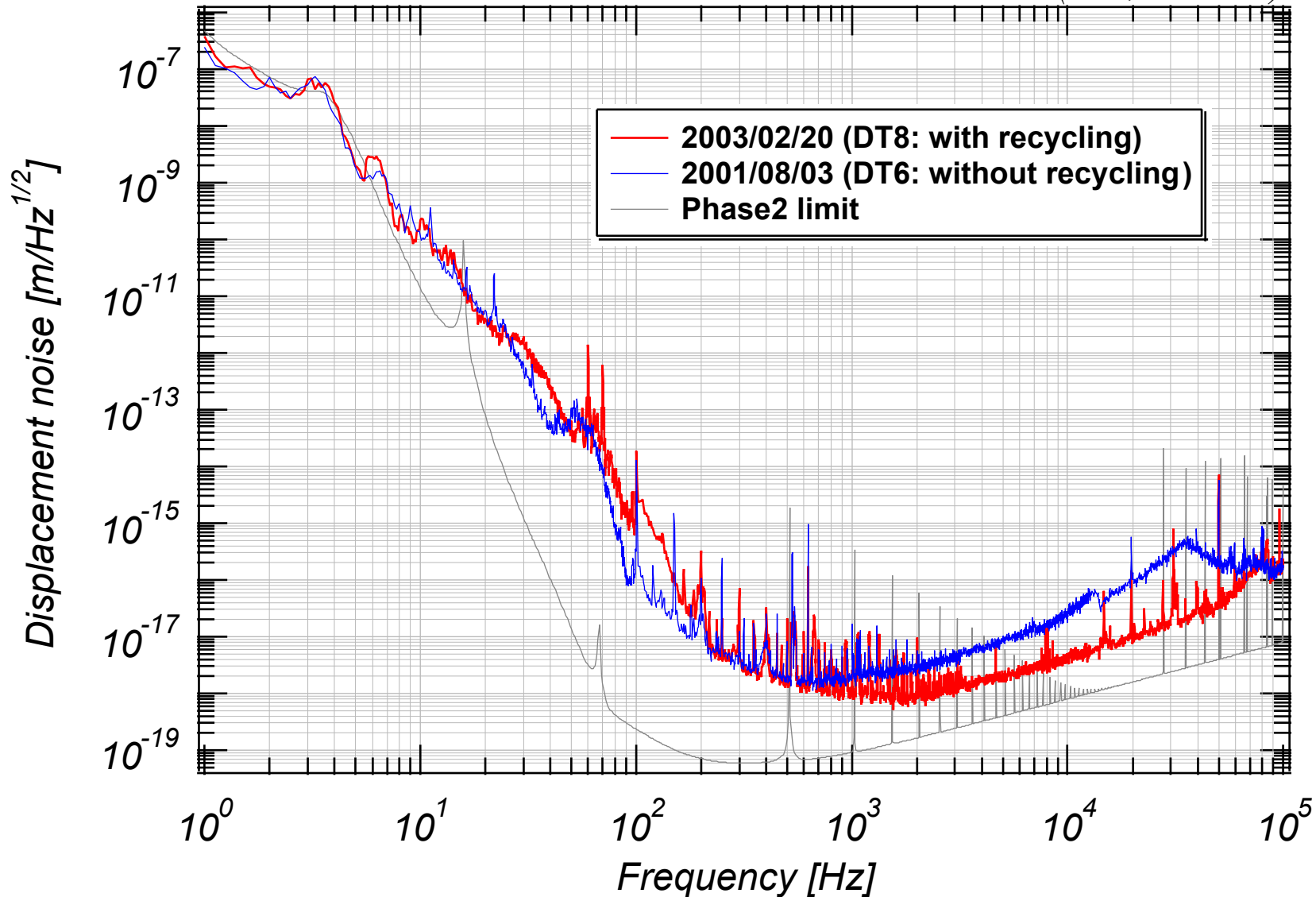

Floor level:  $8 \times 10^{-19}$  m/Hz<sup>1/2</sup> (in displacement)  
 $2.7 \times 10^{-21}$  /Hz<sup>1/2</sup> (in strain)

# Observable distance with SNR=10

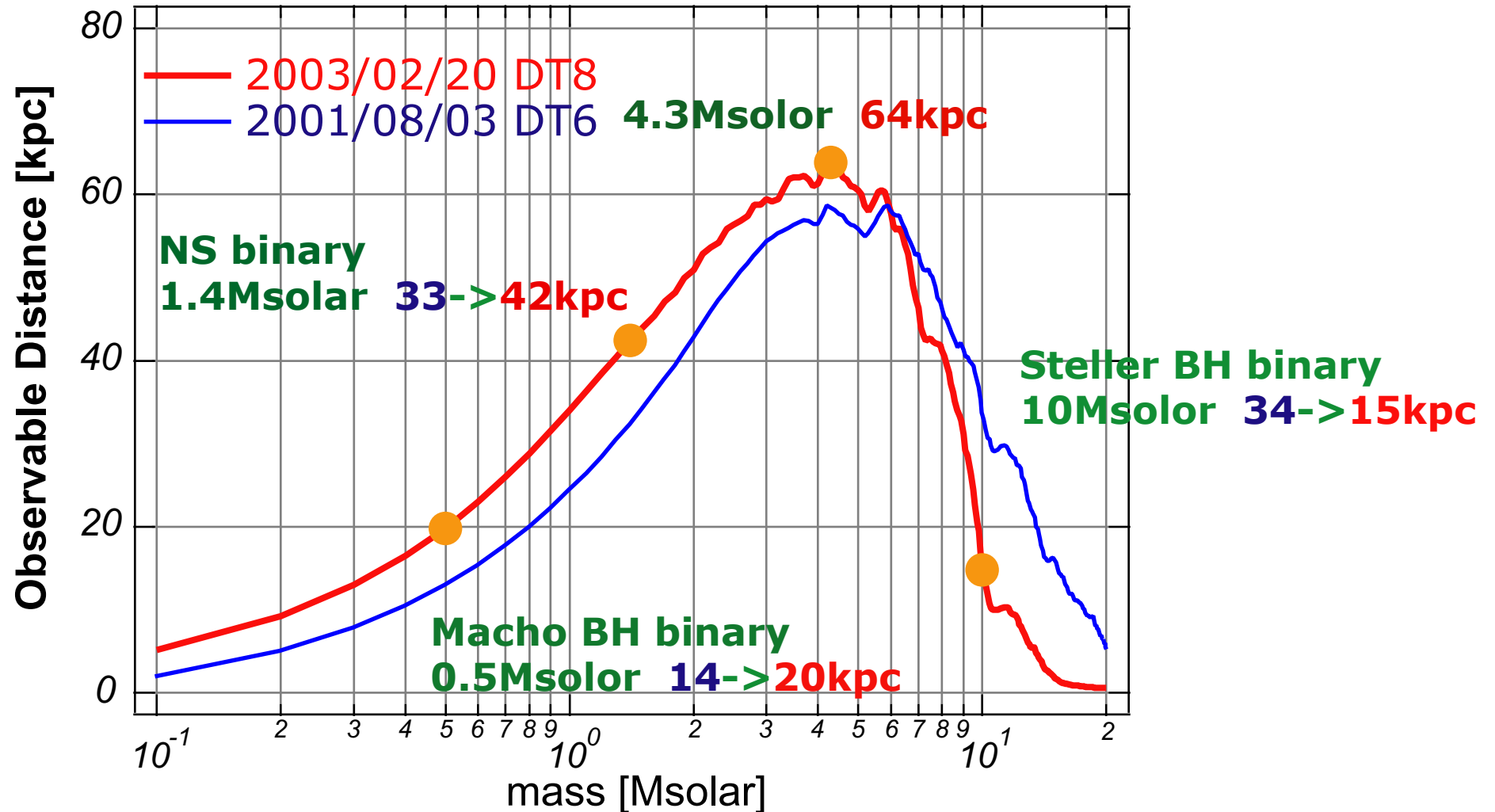

SNR improvement for 1.4-1.4Msolar and 0.5-0.5Msolar

Deterioration for 10-10Msolar caused by wideband alignment filters

# Estimation of noise contributions

## ● Noise estimation based on signal injection

*Laser  
Frequency  
Noise*

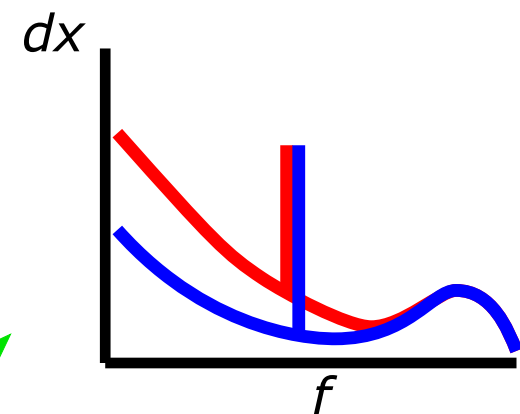
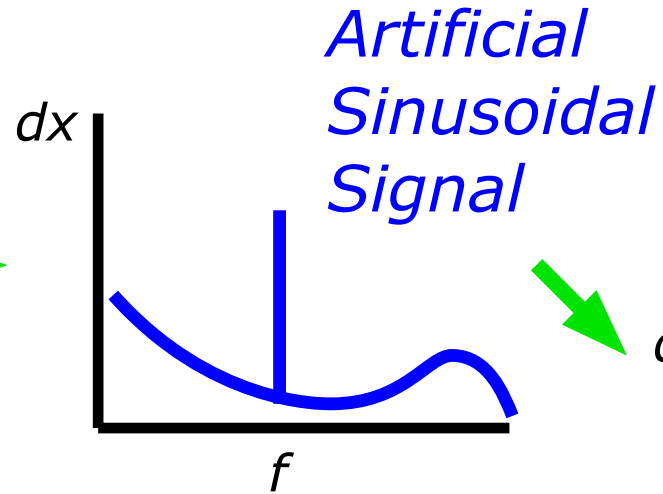
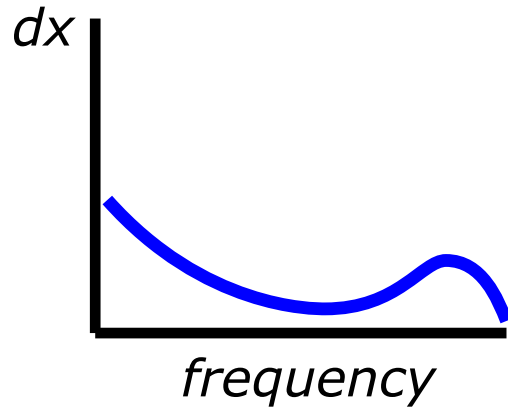

*GW  
Signal  
port*

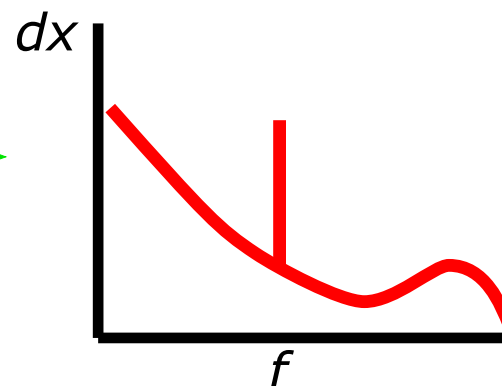
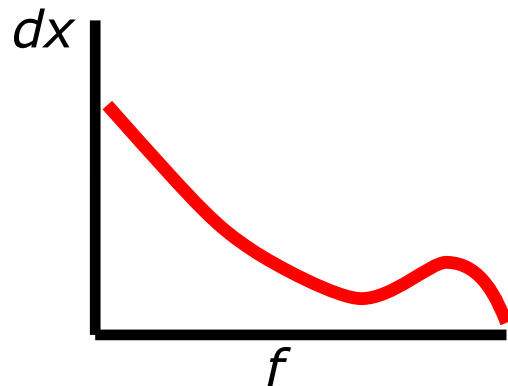

# Displacement noise level of TAMA300

(May 21, 2003)

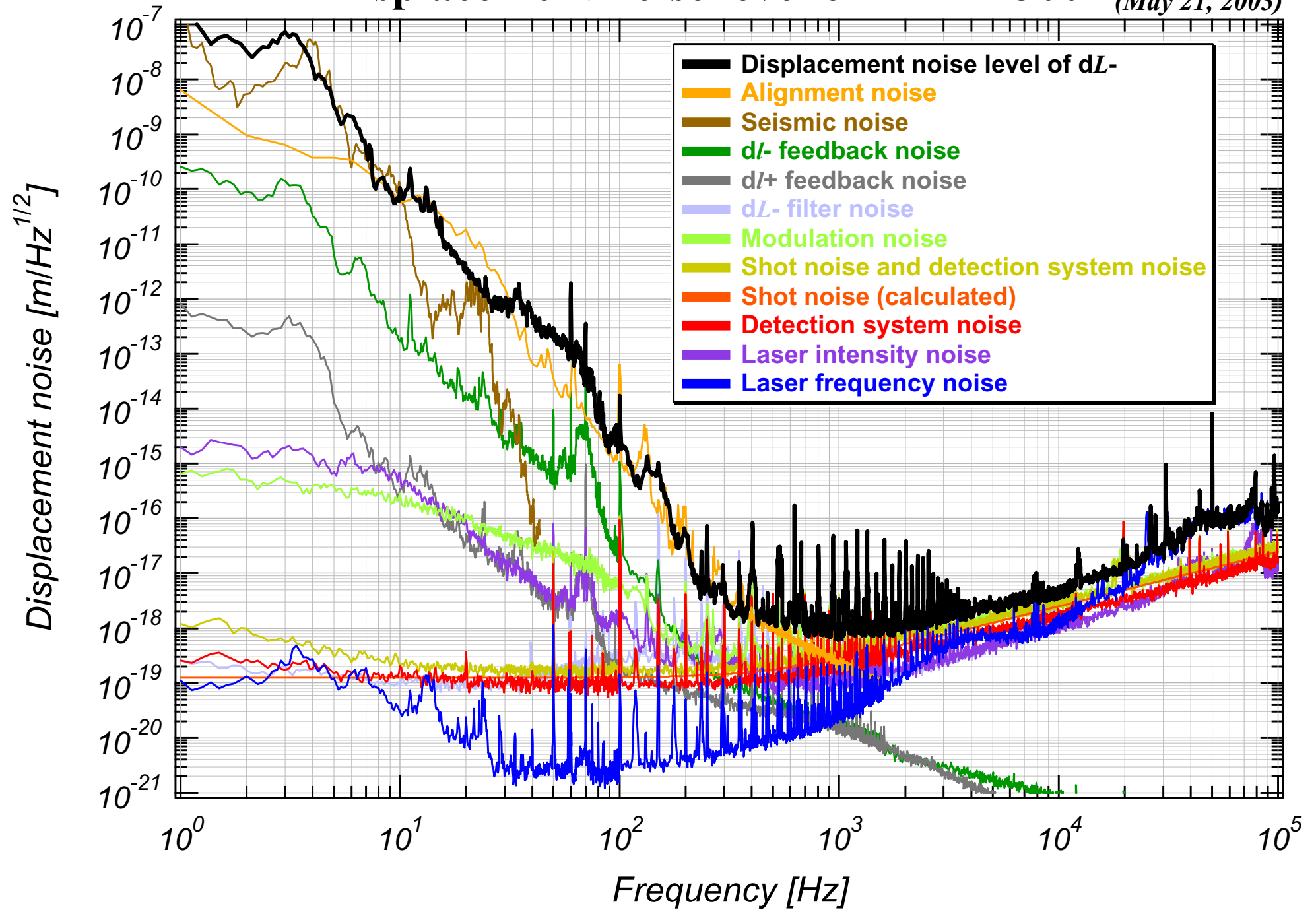

# Observation calendar

● 1157h51m (out of 1424 hours, duty cycle 81.3%)

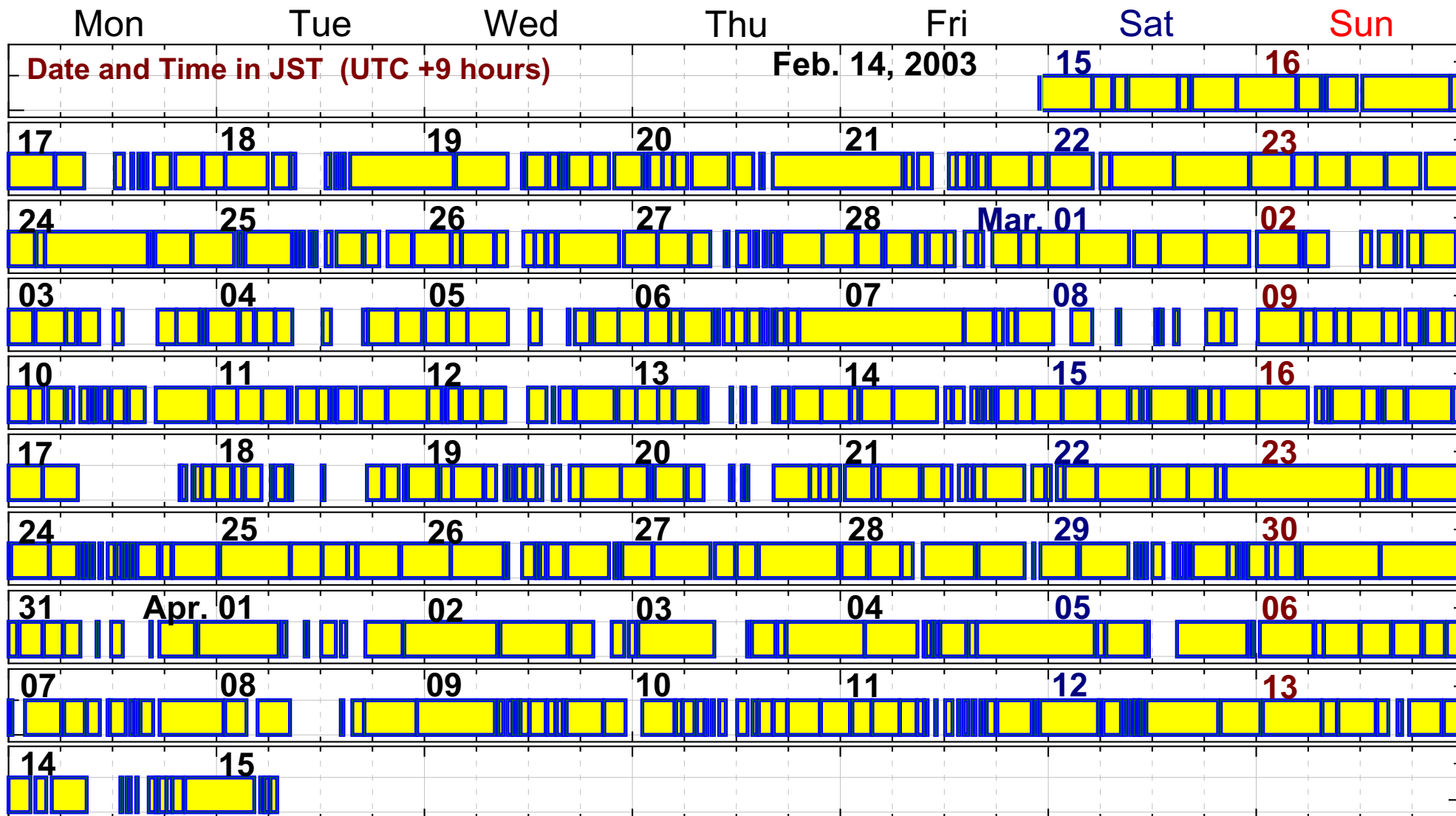



# Duty cycle

Start: Feb 14, 2003, Fri, 23:00:00 JST, End: Apr 15, 2003, Tue, 07:00:00 JST (Total run time: 1424:00:01)  
Total long obs. time: 1157:51:26, Duty cycle: 81.3102%

**Signal Injection Experiment**

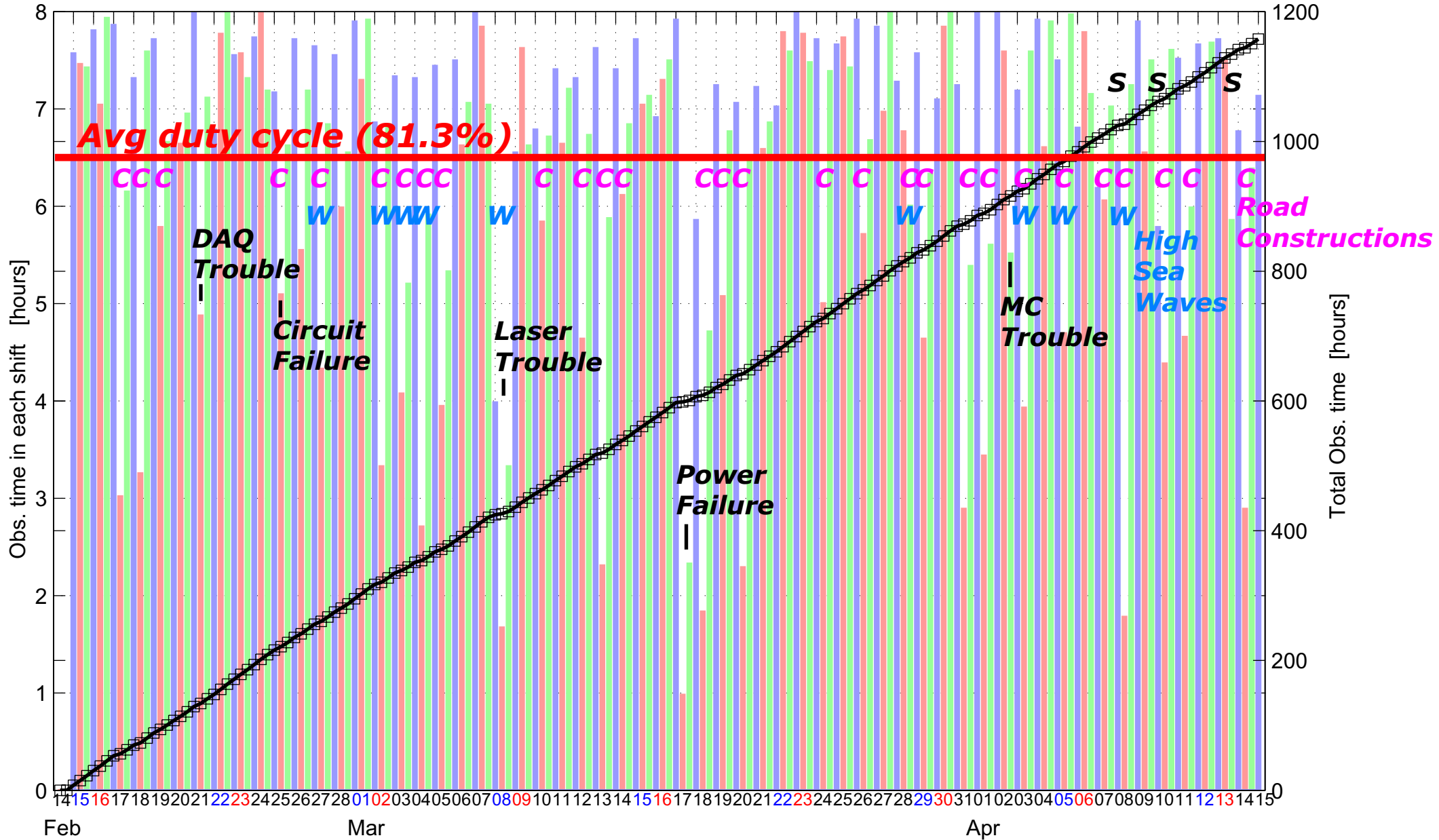

# ***DT8 ~ Disturbance by construction***

11th May, 2003 (Tue)

(Quiet weekday)

15:00 18:00 21:00 00:00 03:00 06:00 09:00 12:00 15:00

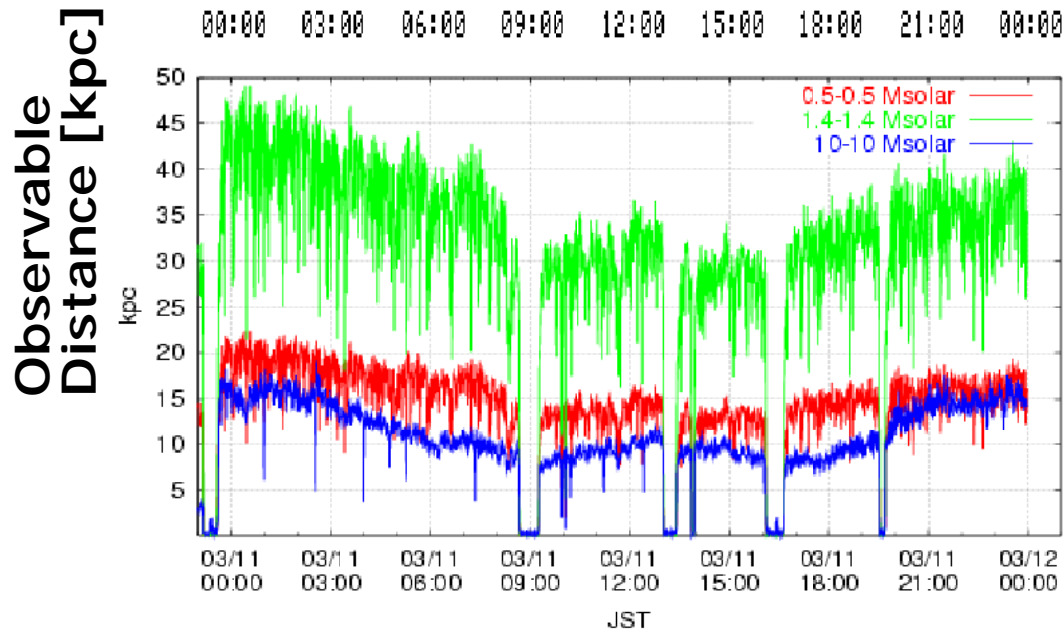
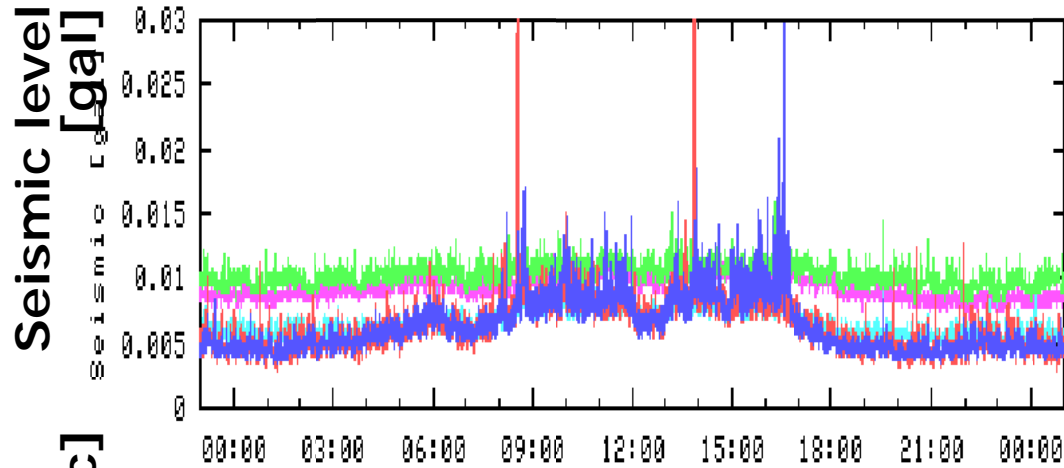

Tue Mar 11 23:59:53 2003

13rd May, 2003 (Thu)

(Noisy weekday)

15:00 18:00 21:00 00:00 03:00 06:00 09:00 12:00 15:00

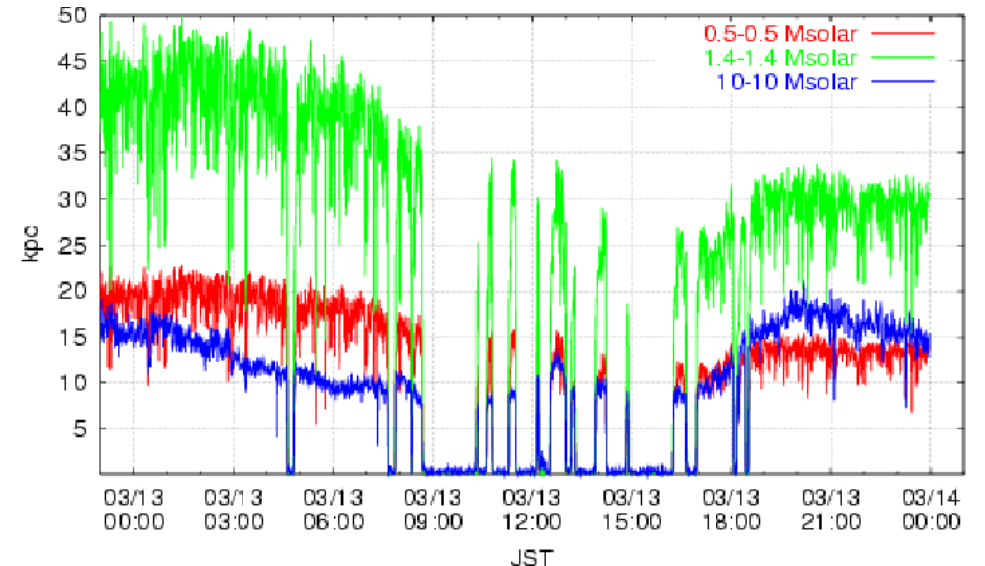
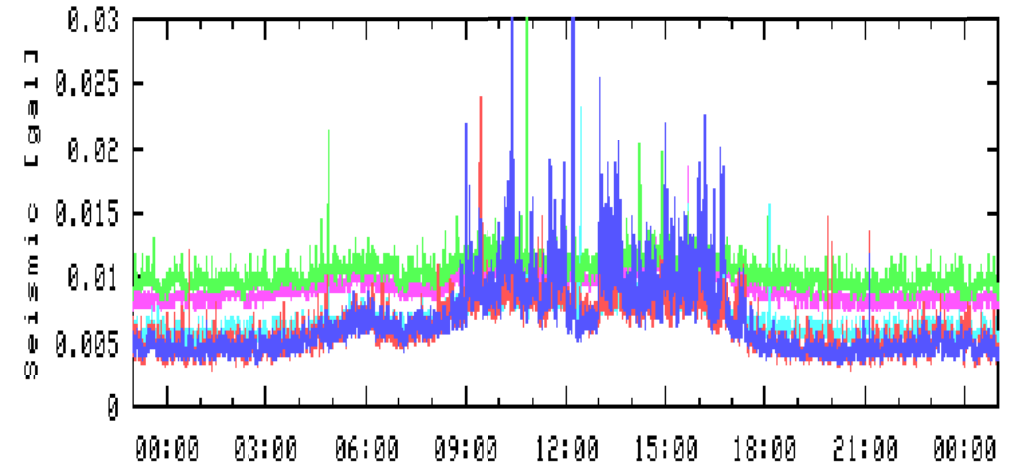

Thu Mar 13 23:59:17 2003

# ***TAMA-LSC working group***

**I Concluded the MOU between TAMA and LSC  
at GWDAAW 2002 in Kyoto**

**Discussions**

**for the joint data analysis  
are now underway!**

**WG members**

- Masaki Ando (University of Tokyo)
- Patrick Brady (University of Wisconsin-Milwaukee)
- Sam Finn (Pennsylvania State University)
- Nobuyuki Kanda (Osaka City University)
- Erik Katsavounidis (MIT)
- Albert Lazzarini (Caltech)
- Hideyuki Tagoshi (Osaka University)
- Ryutaro Takahashi (National Astronomical Observatory of Japan)
- Daisuke Tatsumi (National Astronomical Observatory of Japan)
- Peter Saulson (Syracuse University)

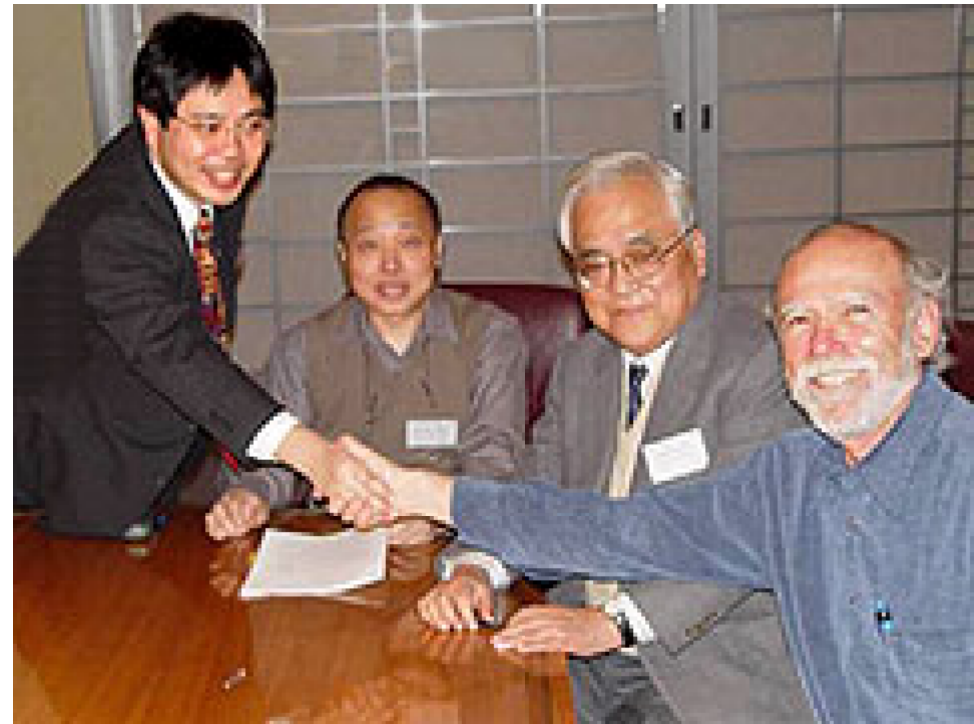

The photograph excerpted  
from LIGO News

# ***Future Plan***

---

- ***Data Analysis of the DT8 data***

In progress

- ***IFO: sufficient stability for long-term obs.***

Concentrate on the noise issues

- ***Further automation of the observation***

To operate the interferometer with less numbers of the interferometer experts on the observations

Ultimately toward a continuous observation

# Summary

- **Interferometric GW detector TAMA300**
- **Data Analysis using DT6 data**

Binary inspirals:  $R_{\text{event}} < 0.0095/\text{hr}$   
coincident search with LISM20m

Burst search: Reduction of the IFO related noise  
 $R_{\text{event}} < 0.01/\text{hr}$  for  $h_{\text{rms}} = 3 \times 10^{-17}$

CW search: Possible 1987A pulsar  $\sim 935\text{Hz}$   
 $h < 4 \times 10^{-23}$

- **Data Taking 8**

Full-time observation with LIGO S2

Power recycling

Improvement of the sensitivity

$$h = 2.7 \times 10^{-21} / \sqrt{\text{Hz}} @ 1.5\text{kHz}$$

1158 hours of 1424 hours => duty cycle 81.3%